

PLAN VIEW

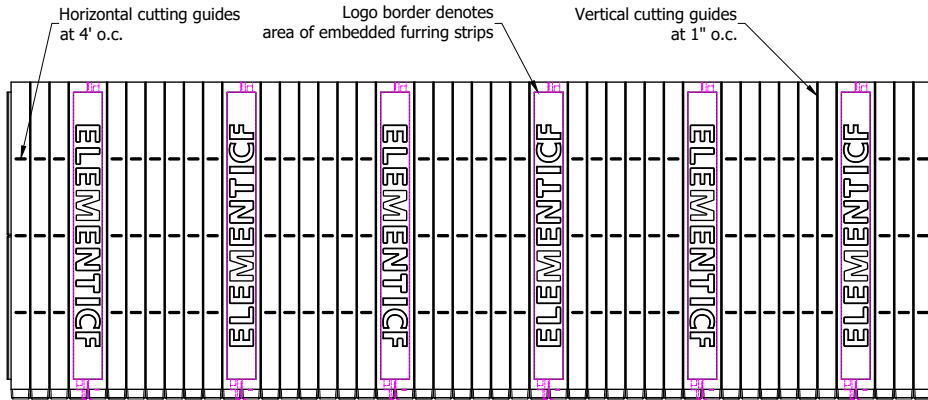

SIDE ELEVATION

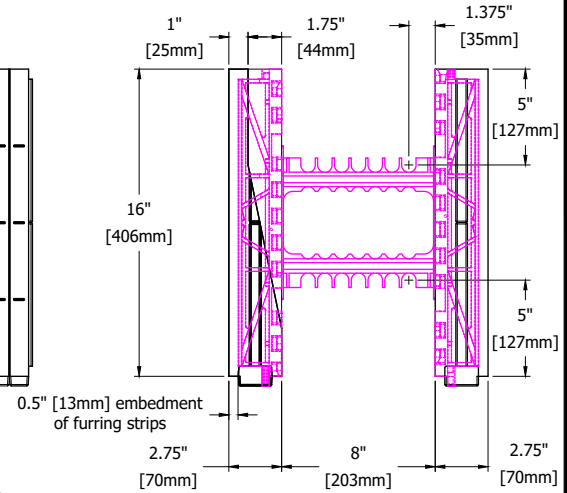

END VIEW

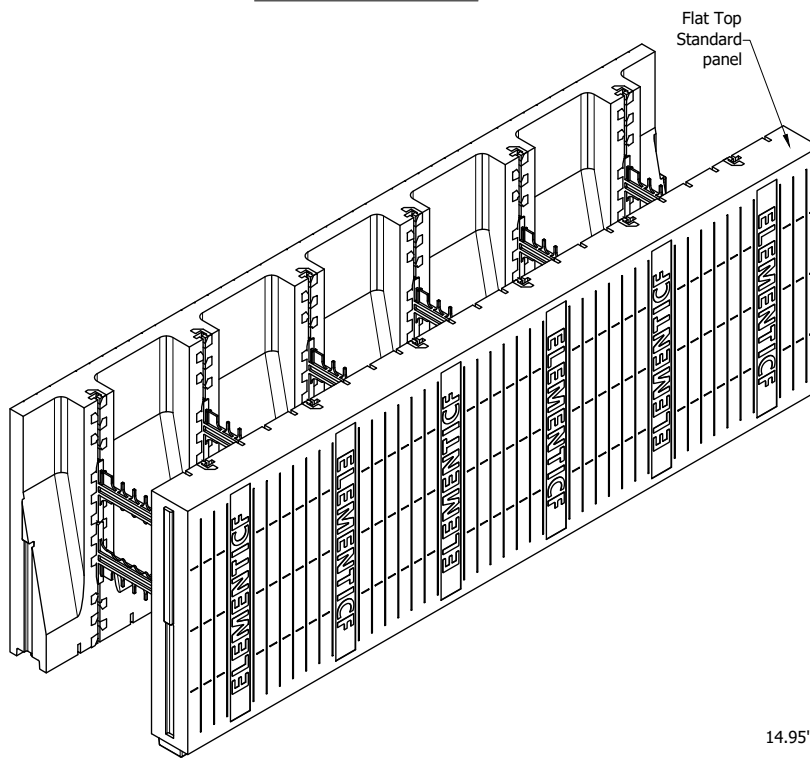

TAPER TOP BLOCK SPECS

Conc. Vol. (y3)	0.14
Conc. Vol. (ft3)	3.87
Conc. Vol. (m3)	0.11
Wall Area (sf)	5.333
R-value*	19.3
RSI*	3.39

*EPS form panels only

NOTES:

1. Element Taper Top block may be available with or without interlock along the top of the Standard panel. Confirm with your local Element ICF representative.

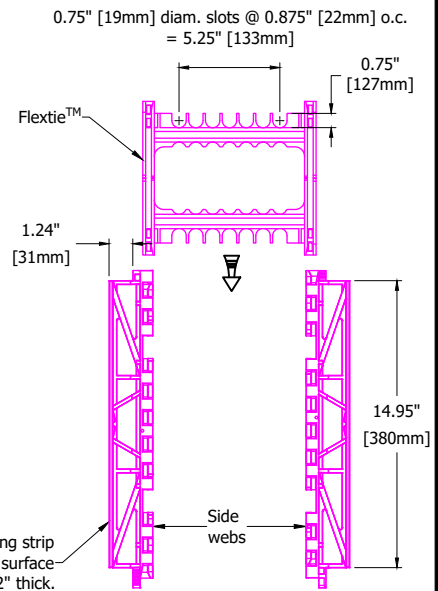

WEB TIE COMPONENTS

