

PLAN VIEW

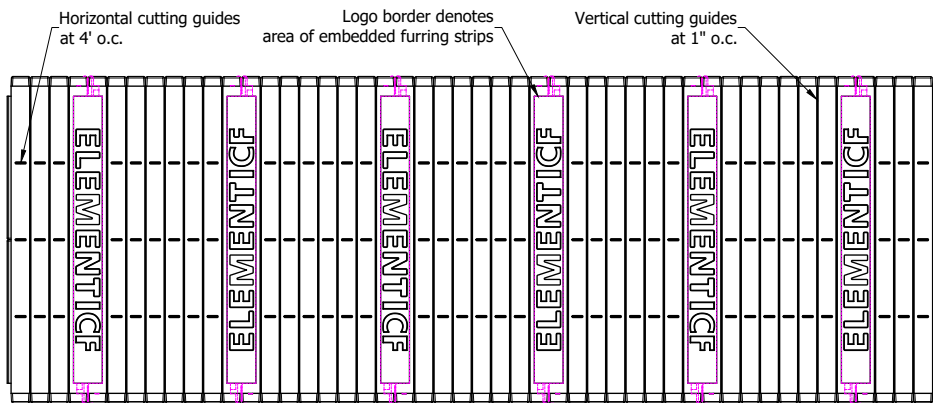

SIDE ELEVATION

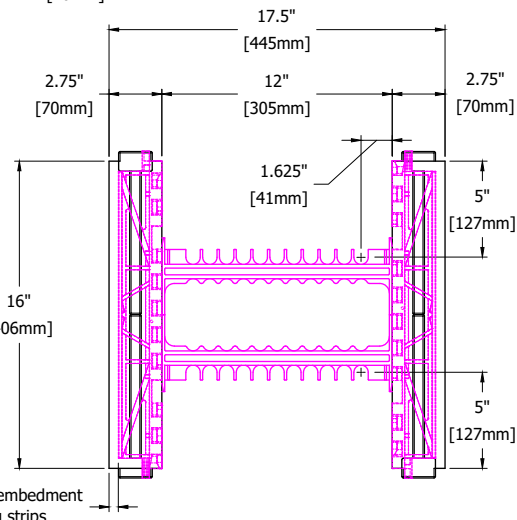

END VIEW

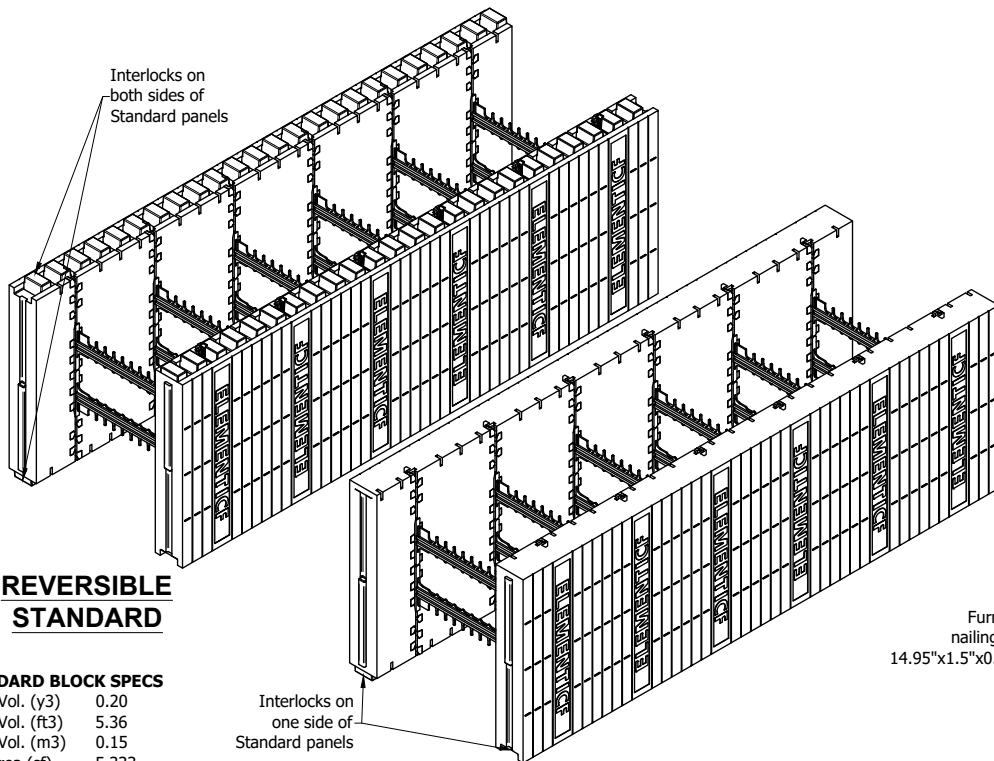

REVERSIBLE STANDARD

FLAT TOP STANDARD

STANDARD BLOCK SPECS

Conc. Vol. (y3)	0.20
Conc. Vol. (ft3)	5.36
Conc. Vol. (m3)	0.15
Wall Area (sf)	5.333
R-value*	22.7
RSI*	4.00

*EPS form panels only

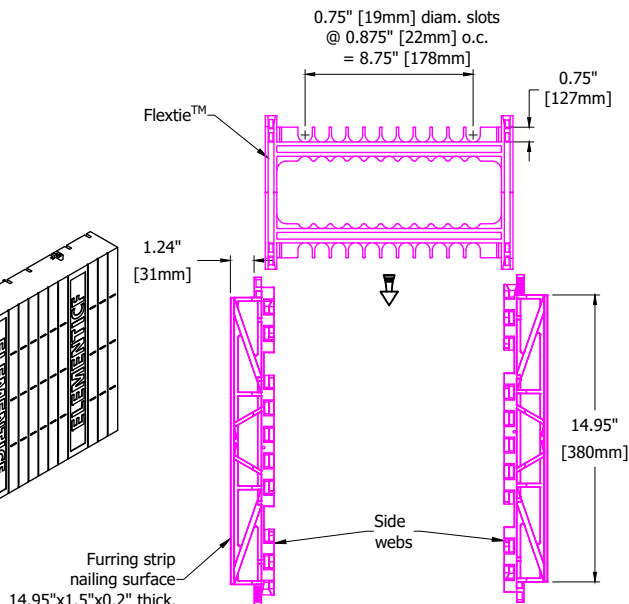

WEB TIE COMPONENTS

NOTES:

1. Check availability of Flat Top Standard blocks with your local Element® ICF representative.



©Copyright Logix Brands Ltd. (Year of Publishing) All rights reserved. No part of the work contained herein as covered by this copyright may be reproduced or used in any form, or any means - graphic, electronic or mechanical, including without limitation photocopying.

By using these drawings, you agree to assume all risks associated therewith. See Logixbrands.com/Disclaimer-Drawings for a full copy of disclaimer.

Drawing:
5.1.1.5 R2

Date:
Jan 16/26

Pg:
1/1

Title:
SITE-ASSEMBLED STANDARD BLOCK (12 INCH)