

# INSTALLATION GUIDE

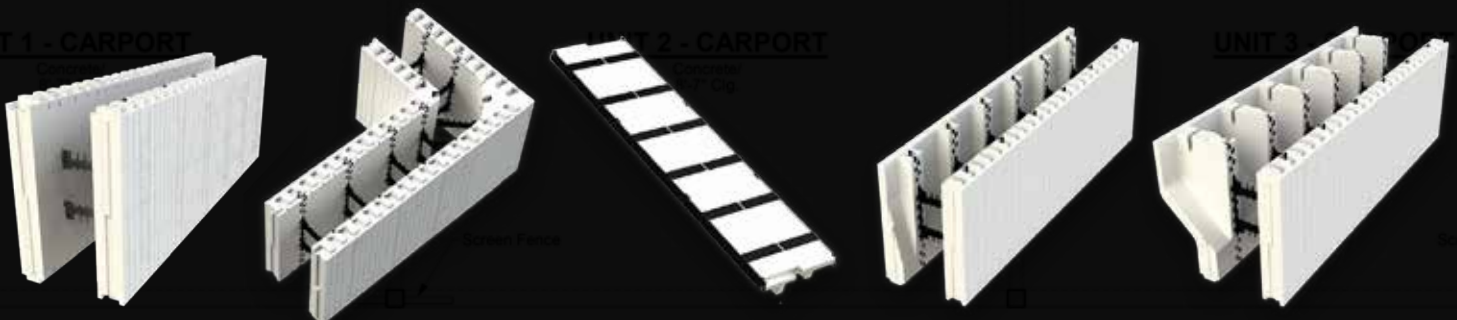
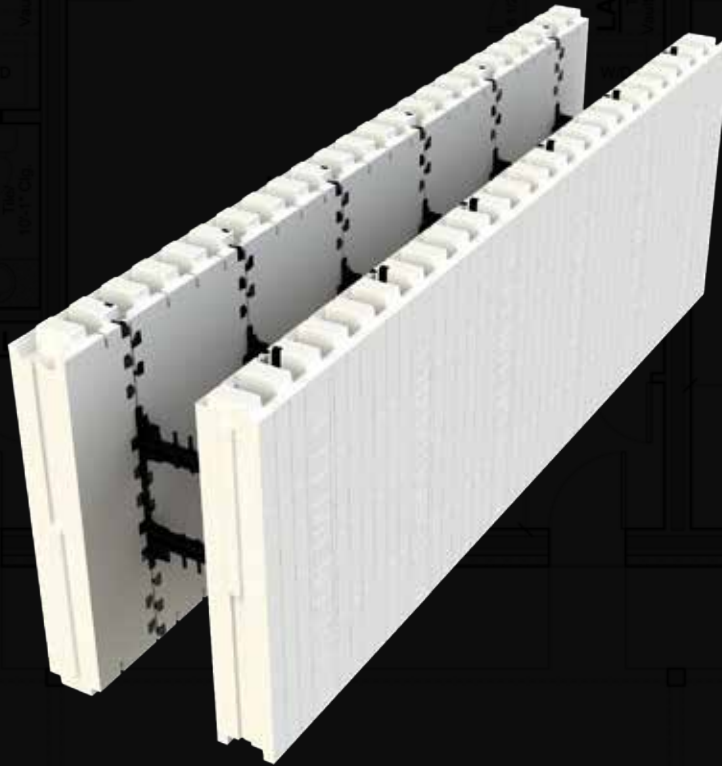

## **DISCLAIMER OF LIABILITY**

Reference to "Logix Brands Ltd." means the manufacturer (the "Manufacturer") selling the product(s) referenced in the Title section (the "Products") of the enclosed drawings (the "Drawings") to consumers (the "User"). The Manufacturer sells its Products "as is" and the consents of the Drawings are provided "as is".

**NO EXPRESS WARRANTIES ARE GIVEN. ALL WARRANTIES, EXPRESS, STATUTORY AND IMPLIED, INCLUDING BUT NOT LIMITED TO, WARRANTIES OF MERCHANTABILITY AND FITNESS FOR A PARTICULAR PURPOSE, ARE EXPRESSLY DISCLAIMED.**

The User assumes all risks as to the use of the Products and/or the Drawings.

The Drawings are to be used as reference guides only. The User shall confirm the information contained in the Drawings meets local building codes and construction practices by consulting with local building officials and professionals, and determine if there are any additional building and/or construction requirements. Before use, the User should fully investigate the Products to enable informed choices as to suitability for a particular construction project and proper design and implementation. It is the User's responsibility and obligation to ensure all work performed conforms to applicable building code and labour safety regulations governing the construction.

As the Manufacturer has no control over installation design and workmanship, accessory materials or application conditions, the Manufacturer does not warranty the performance or results of any installation containing the Products and/or derived from the Drawings. The User acknowledges that it has not relied upon any representation, condition or warranty made by the Manufacturer or any other person on the Manufacturer's behalf.

The Manufacturer assumes no responsibility that its Products will be fit for any particular purpose, the Manufacturer will not be liable for any direct, incidental, consequently or indirect damages (including lost profits) arising out of the use of its Products and/or the Drawings.

The Manufacturer reserves the right to make changes to the Drawings without notice and assumes no liability in connection with the use of the Drawings.

© Copyright Logix Brands Ltd. 2023 All rights reserved.

No part of the work contained herein as covered by this copyright may be reproduced or used in any block, or any means – graphic, electronic or mechanical, including without limitation photocopying.

**TABLE OF CONTENTS**

2.1 – INTRODUCTION ..... 2-6

2.2 – STRUCTURE OF AN ELEMENT ICF BLOCK ..... 2-7

2.3 – USEFUL TOOLS & MATERIALS ..... 2-9

2.4 – ACCURATE FOOTINGS & SLABS ..... 2-10

2.5 – WALL LAYOUT ..... 2-11

2.6 – PRODUCT HANDLING & PLACEMENT ..... 2-12

2.7 – JOBSITE EFFICIENCY ..... 2-13

2.8 – ELEMENT WALL CONSTRUCTION ..... 2-14

2.8.1 – THE FIRST COURSE ..... 2-15

2.8.2 – THE SECOND COURSE ..... 2-17

2.8.3 – ADDITIONAL COURSES ..... 2-20

2.8.4 – COURSE HEIGHTS ..... 2-21

    2.8.4.1 – HEIGHT ADJUSTERS WITH SITE-ASSEMBLED BLOCKS ..... 2-22

    2.8.4.2 – HEIGHT ADJUSTERS WITH PREFORMED BLOCKS ..... 2-23

    2.8.4.3 – HALF-HEIGHTS ..... 2-24

2.8.5 – CORNER BRICK LEDGE AND TAPER TOPS ..... 2-26

    2.8.5.1 – BRICK LEDGE CORNERS ..... 2-26

    2.8.5.2 – CORNER TAPER TOP FROM MITRE CUTS ..... 2-28

    2.8.5.3 – CORNER TAPER TOP FROM STANDARD CORNERS ..... 2-30

2.8.6 – TEE WALLS ..... 2-32

2.8.7 – GABLE WALLS ..... 2-33

2.8.8 – RADIUS WALLS ..... 2-34

2.8.9 – ELEMENT XRV INSERT PANELS ..... 2-35

2.9 – REINFORCEMENT ..... 2-36

    2.9.1 – BASIC REINFORCEMENT ..... 2-36

    2.9.2 – HORIZONTAL & VERTICAL REINFORCEMENT ..... 2-37

    2.9.3 – HORIZONTAL REBAR SPACINGS ..... 2-38

    2.9.4 – TYPICAL REINFORCEMENT AT OPENINGS ..... 2-39

    2.9.5 – LINTELS ..... 2-40

2.10 – WINDOW & DOOR BUCKS ..... 2-41

    2.10.1 – PRO BUCK™ ..... 2-42

    2.10.2 – TREATED PLYWOOD BUCK ..... 2-47

    2.10.3 – SOLID WOOD BUCK ..... 2-48

TABLE OF CONTENTS

## TABLE OF CONTENTS

2.10.4 – RADIUS OPENINGS .....	2-49
2.10.5 – METAL JAMBS .....	2-50
<b>2.11 – ADDITIONAL BLOCK SUPPORT.....</b>	<b>2-51</b>
2.11.1 – STRAPPING AND BRACING.....	2-51
2.11.2 – CORNER BLOCK SUPPORT .....	2-53
2.11.3 – ELEMENT BRIDGING FLEXTIES.....	2-55
<b>2.12 – WALL BRACING &amp; ALIGNMENT SYSTEM.....</b>	<b>2-56</b>
<b>2.13 – FLOOR CONNECTIONS.....</b>	<b>2-57</b>
2.13.1 - LEDGER WITH ANCHOR BOLTS & JOIST HANGERS .....	2-57
2.13.2 – STEEL ANGLE IRON LEDGER.....	2-58
2.13.3 – BRICK LEDGE FOR TOP & BOTTOM CHORD BEARING SYSTEMS.....	2-60
2.13.4 – LEDGER WITH SIMPSON BRACKET & JOIST HANGERS.....	2-61
2.13.5 – TRANSITION LEDGE.....	2-64
2.13.5.1 – TRANSITION LEDGE WITH CORNER BLOCKS .....	2-65
2.13.6 – TAPER TOP WITH SILL PLATE .....	2-67
2.13.7 – CONCRETE FLOOR SYSTEMS .....	2-68
2.13.7.1 – PRECAST CONCRETE FLOORS .....	2-68
2.13.7.2 – COMPOSITE FLOOR SYSTEMS .....	2-69
<b>2.14 – ROOF CONNECTIONS .....</b>	<b>2-70</b>
<b>2.15 – SERVICE PENETRATIONS.....</b>	<b>2-71</b>
<b>2.16 – CONCRETE PLACEMENT.....</b>	<b>2-72</b>
2.16.1 – PRE-PLACEMENT CHECKLIST .....	2-72
2.16.2 – MIX DESIGN.....	2-73
2.16.3 – BEST PRACTICES.....	2-74
2.16.4 – PLACING CONCRETE.....	2-75
2.16.5 – POST-PLACEMENT CHECKLIST .....	2-76
<b>2.17 – ELECTRICAL INSTALLATIONS.....</b>	<b>2-77</b>
<b>2.18 – PLUMBING INSTALLATIONS .....</b>	<b>2-78</b>
<b>2.19 – INTERIOR &amp; EXTERIOR FINISHES .....</b>	<b>2-79</b>
2.19.1 – VAPOR & AIR BARRIERS.....	2-79
2.19.2 – INTERIOR DRYWALL.....	2-80
2.19.3 – EXTERIOR SIDING.....	2-81
2.19.4 – STEEL PANEL SIDING .....	2-82

**TABLE OF CONTENTS**

2.19.5 – WOOD SIDING .....2-83

2.19.6 – EIFS ..... 2-84

2.19.7 – CEMENT COMPOSITE SIDING .....2-85

2.19.8 – BRICK VENEER ..... 2-86

2.19.9 – BELOW GRADE WATERPROOFING, DAMPPROOFING & PARGING.....2-87

    2.19.9.1 – BELOW GRADE WATERPROOFING.....2-87

    2.19.9.2 – ABOVE GRADE PARGING.....2-89

**2.20 – ATTACHING FIXTURES .....2-90**

    2.20.1 - LIGHT WEIGHT FIXTURES .....2-90

    2.20.2 - HEAVY WEIGHT FIXTURES.....2-90

        2.20.2.1 – CABINETS .....2-91

        2.20.2.2 - GRAB BARS .....2-92

        2.20.2.3 – TELEVISIONS.....2-93

**2.21 – HOLDING POWER OF SCREWS FASTENED TO ELEMENT FURRING STRIPS .....2-94**

**2.22 – RADIUS WALLS .....2-95**

**2.23 – TALL WALLS .....2-104**

**2.24 – SUPPORTING PRODUCTS .....2-106**

## 2.1 – INTRODUCTION

For builders who want a competitive edge, Logix® Brands offers solid products and friendly local service. Our products are designed to perform better in the field, providing trouble-free, profitable installations time after time.

Our technical team is ready to respond to your queries with practical advice on quick and efficient installation. With contractor training provided through our numerous regional technical support offices, help is always close at hand.

We are the most experienced ICF manufacturers in North America, manufacturing top quality products at company-owned plants that are located throughout the United States and Canada.

For more information, or to contact an Logix® Brands representative, visit our product website at [www.ElementICF.com](http://www.ElementICF.com) and click “Contact Us” You can also register online to receive Element ICF updates.

This manual will be updated regularly. Current updates will be available at [www.ElementICF.com](http://www.ElementICF.com).

## 2.2 – STRUCTURE OF AN ELEMENT ICF BLOCK

### SITE-ASSEMBLED STANDARD BLOCK

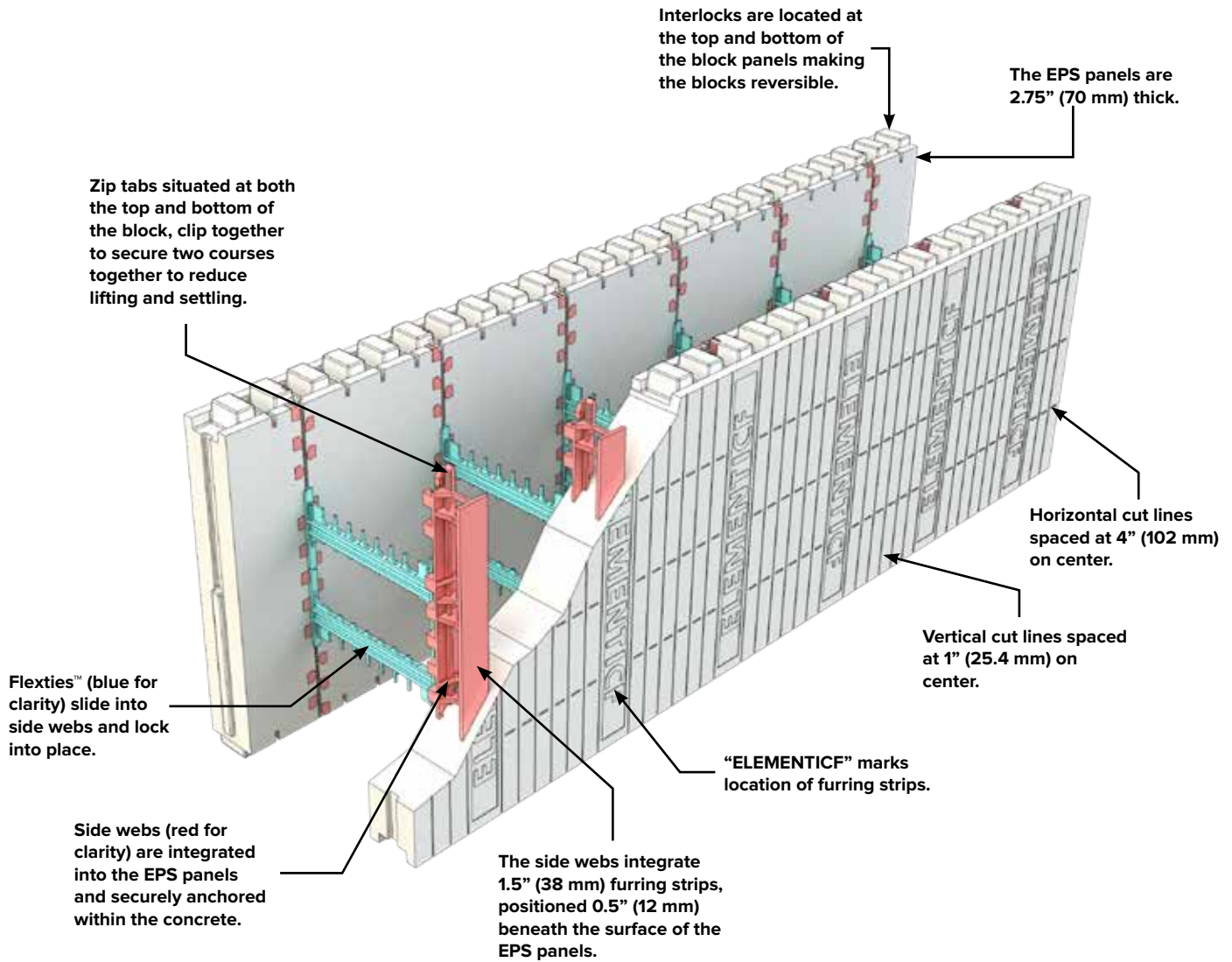

Side webs and Flexties are spaced at 8" (203 mm) on center.

PREFORMED STANDARD BLOCK

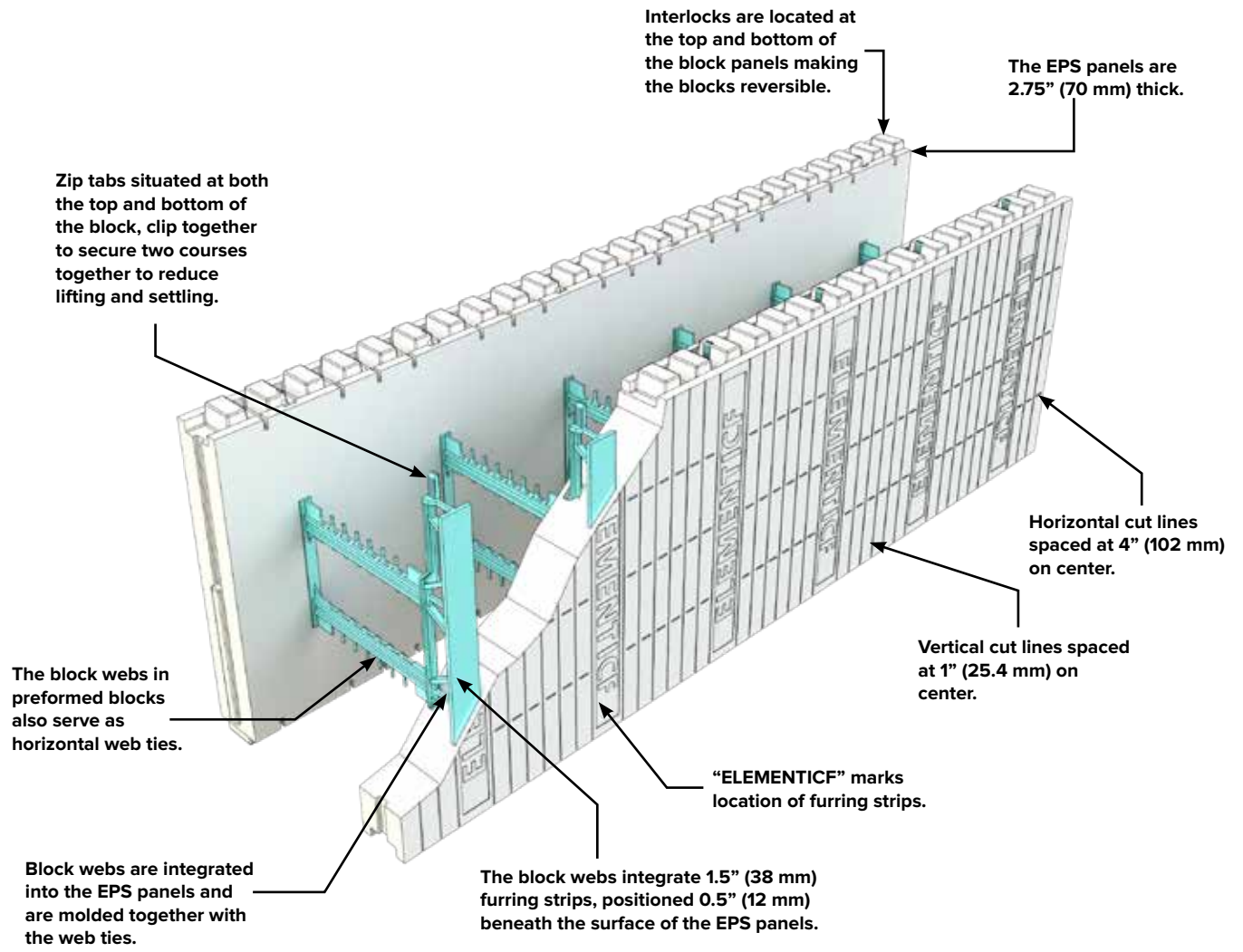

Side webs and web ties are spaced at 8" (203 mm) on center.

INSTALLATION GUIDE - INTRODUCTION



## 2.3 – USEFUL TOOLS & MATERIALS

- Pruning saw
- Cordless drill
- Screws
- Hot knife
- Electric chainsaw
- Fiberglass-reinforced tape
- Step ladder
- Rebar bender/cutter
- Internal vibrator
- Contractor-grade foam gun
- Low expansion foam adhesive
- Approved scaffold planks
- Transit or laser
- 48” (1220mm) level
- Bolt cutters
- String line
- Chalk line
- Wall alignment system (safety compliant)
- 36 inch (914 mm) plastic zip ties
- Concrete embedments
- Window and door buck material
- Sleeves for wall penetrations

## 2.4 – ACCURATE FOOTINGS & SLABS

The first step to a successful Element installation is an accurate footing or slab. This means a footing or slab that is:

- Code compliant
- Designed in accordance with construction drawings and specifications
- Designed taking into account soil conditions, seismic area, number of stories, building loads, and water tables.

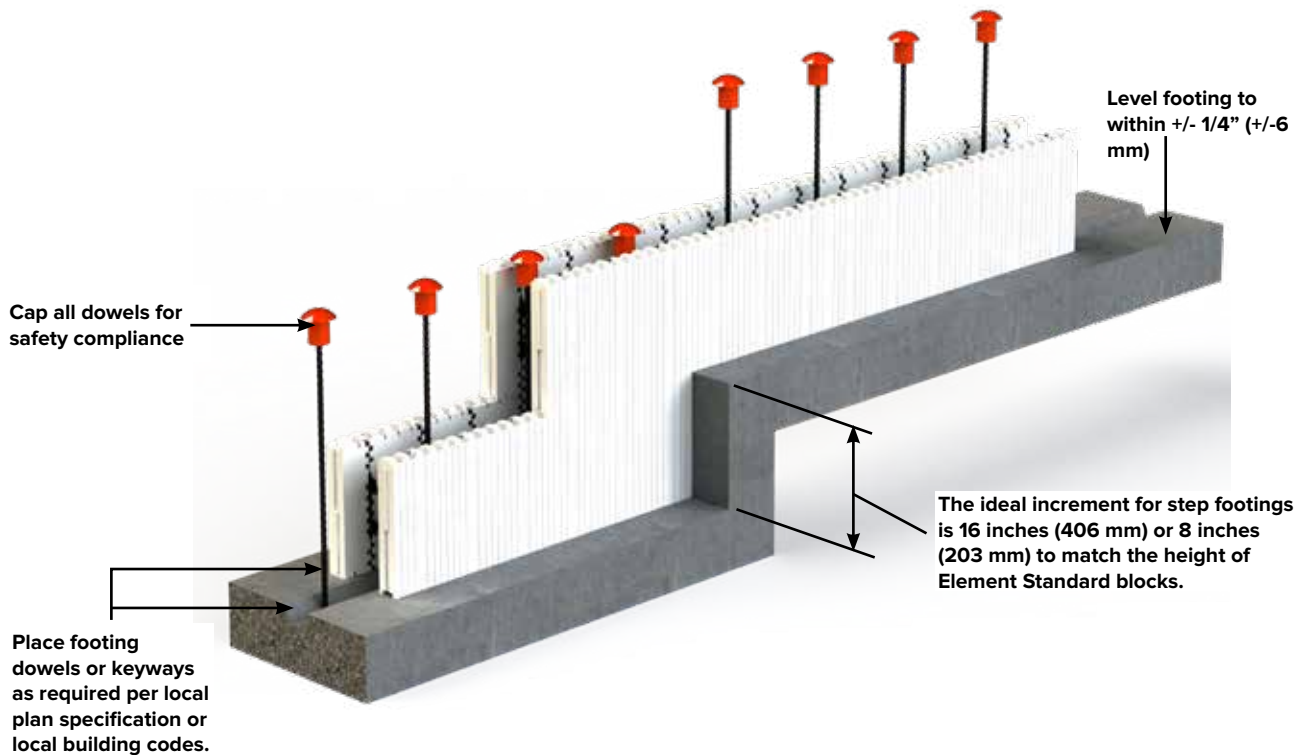



## 2.5 – WALL LAYOUT

Accurate wall layout is critical to ensure a complete and profitable Element project.

Verify that wall layout is in accordance with plans and specifications.

In addition to straight Standard blocks, Element provides 90° corner blocks. Element can be easily cut on-site to fit any corner angle or radius. See “2.8.8 – RADIUS WALLS” on page 34.

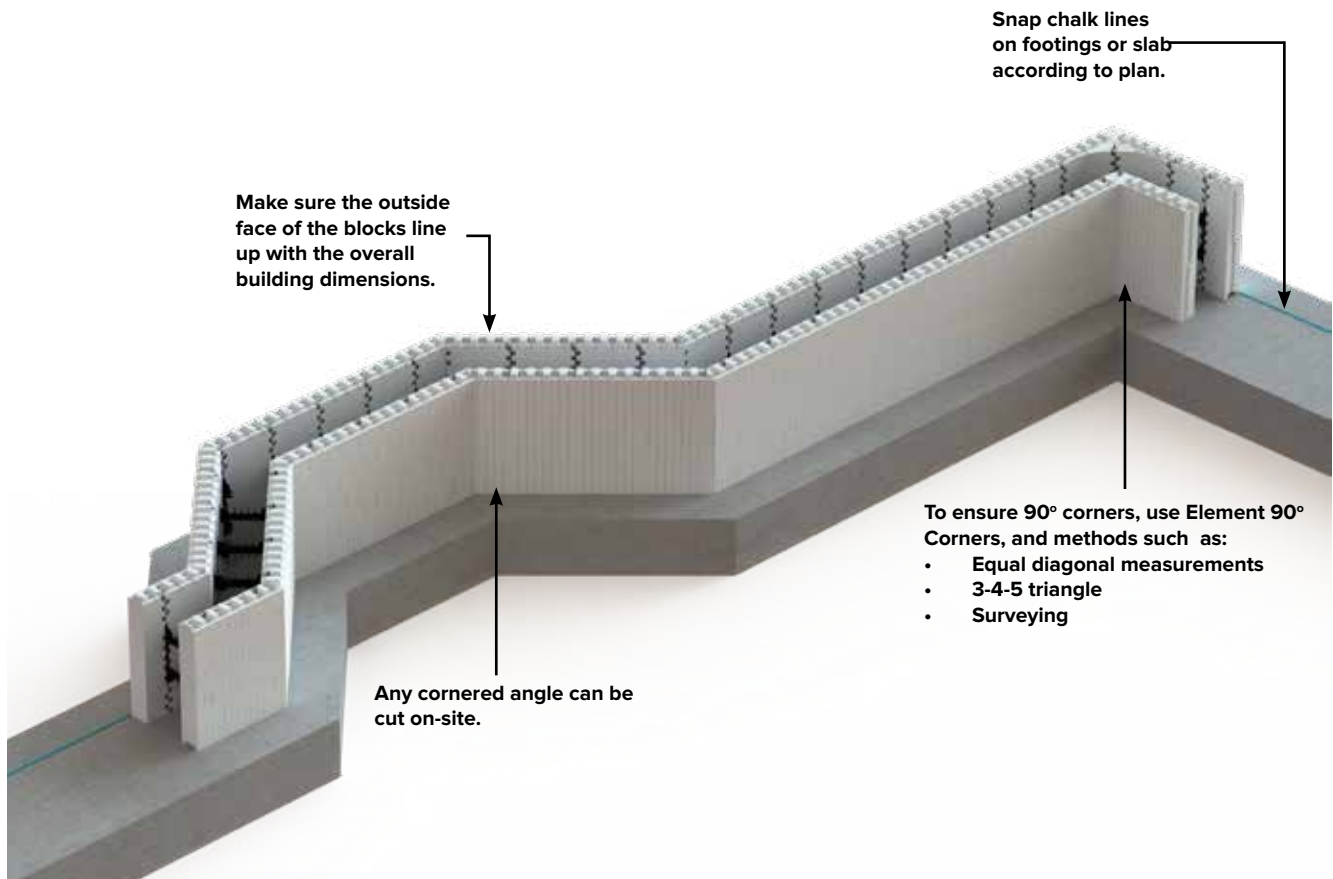

## 2.6 – PRODUCT HANDLING & PLACEMENT

There are several methods to efficiently handle Element products. Unlike most ICF systems, the consistent 2-3/4 inch (70 mm) panel thickness on Element blocks means that handling damage is minimized.



- Element panels are packaged in bags, with six standard panels per bag. The bags of standard panels are loaded on a skid and shrink wrapped.
- Element blocks are wrapped together in convenient cubes for easy handling.
- Flexties for site-assembled blocks are shipped in boxes.
- Unloading can be accomplished manually. However a pallet jack and forklift can be very useful, especially to unload the skids of Element panels.
- Corner blocks and panels are bundled into easy-to-handle cubes.
- When tying blocks down on an open trailer, ensure the blocks are well secured and avoid block damage from strapping materials.
- Element blocks are produced with a tight tolerance: a length tolerance of +/-1/8 inch (+/-3 mm), and a height tolerance of +/-1/16 inch (+/-2 mm).

When blocks are unloaded, it is necessary to measure blocks to determine uniform length and height. It is suggested to measure 2 blocks per skid. In the unlikely event that blocks are out of spec, please contact the local Element representative immediately.



## 2.7 – JOBSITE EFFICIENCY

An efficient jobsite means a faster and safer installation, and ultimately a higher quality finished project.

- Keep all materials and tools outside of the footing area until the chalk lines have been snapped and the wall layout is complete. Generally, construction is accomplished from within the perimeter of the structure.
- When wall layout is complete, place blocks at least 7 feet (2.134 m) inside the perimeter of the footings or slab to accommodate the wall alignment system.
- Space skids of standard blocks around the inside of the entire perimeter.

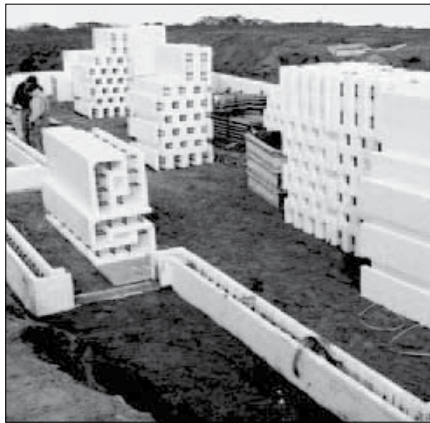

**NOTE:** When placing courses of blocks, always take blocks from the closest skid. This will eliminate the effects of normal manufacturing variations between skids.

- Periodic checking of dimensions ensures accurate wall construction.
- Additional materials that should be located within the perimeter:
  - Window and door bucks
  - Rebar (straight or pre-bent)
  - Alignment system
  - Approved scaffold planks
  - Tools

## 2.8 – ELEMENT WALL CONSTRUCTION

When a block is cut, it can be identified using bars and webs. For example, a cut block with three bars, two webs, and three bars will be referred to as a “3-2-3”.

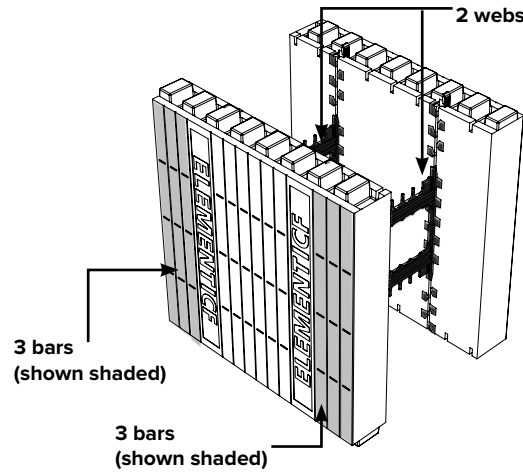

By establishing a logical block pattern that takes into account the building dimensions, maximum efficiency will be achieved. It is important that the building dimensions have a tolerance of +/-1/2" inch (13 mm) or a stacked vertical joint will result. Such joints are acceptable if dimensions necessitate but will require additional block support on both sides of the block.

When building dimensions are based on 4 feet (1.219 m) increments, it is recommended to maintain a staggered joint pattern at the corners by reversing the orientation of the corner blocks..

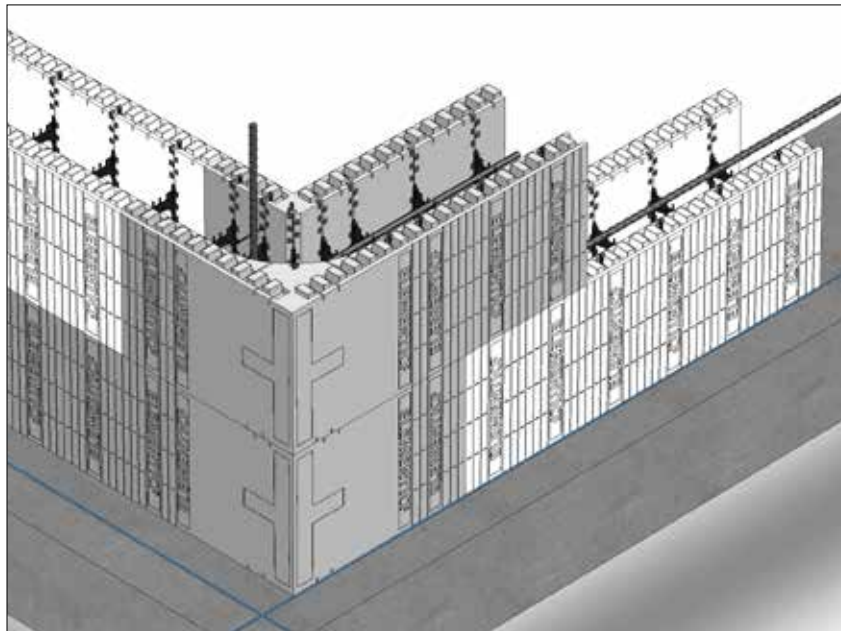

Alternating corner blocks are achieved by flipping the reversible corner blocks.

2.8.1 – THE FIRST COURSE

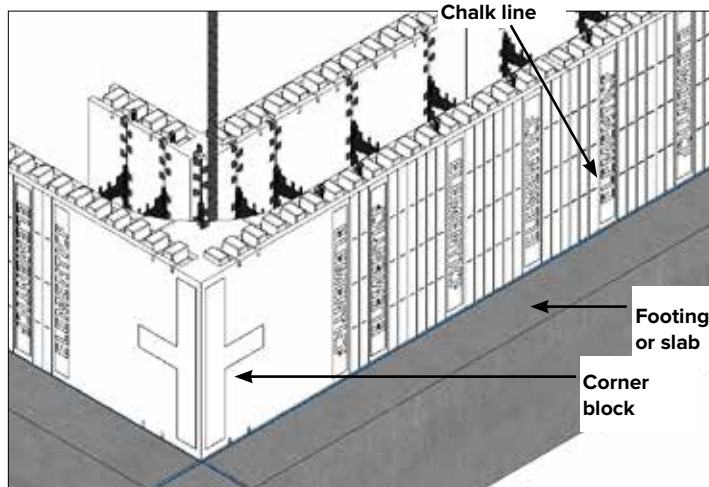

STEP 1: Start first course at a corner and align with chalk line. The interlocks at the bottom of the blocks can be removed, if preferred.

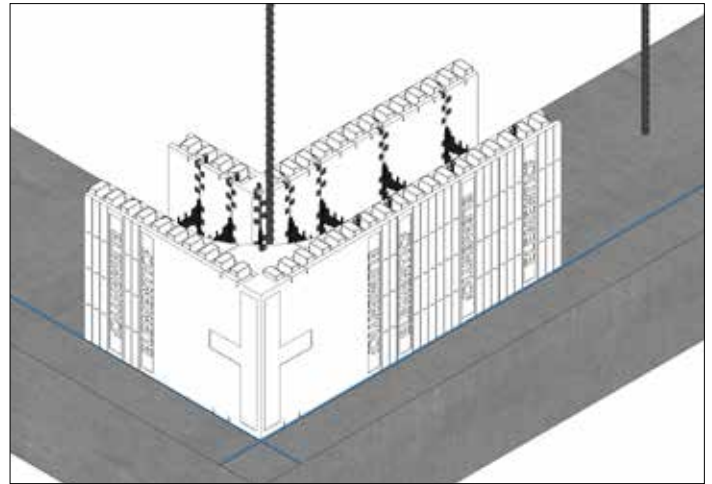

STEP 2: Continue placing blocks along the chalk line.

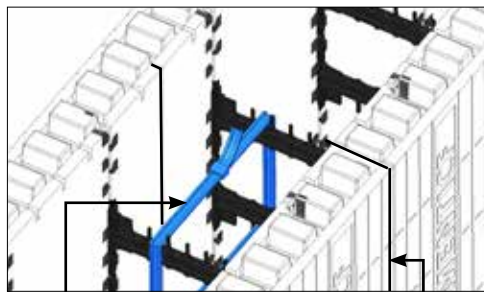

STEP 3: Secure blocks end-to-end to maintain building dimensions using zip ties.

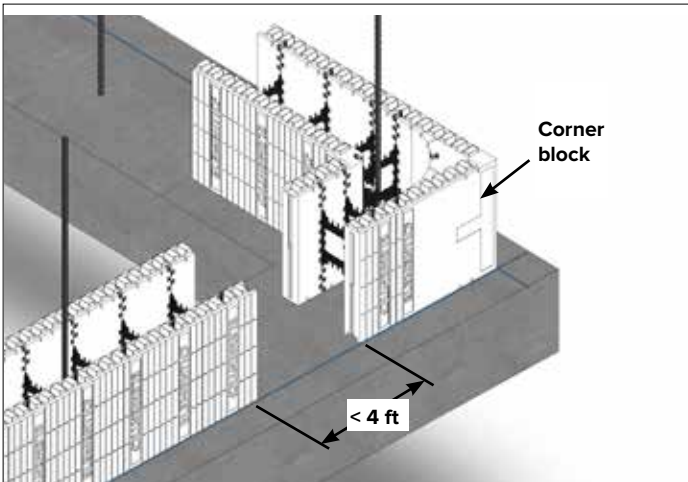

**STEP 4:** When blocks are 4 ft or less from the second corner, place the second corner block.

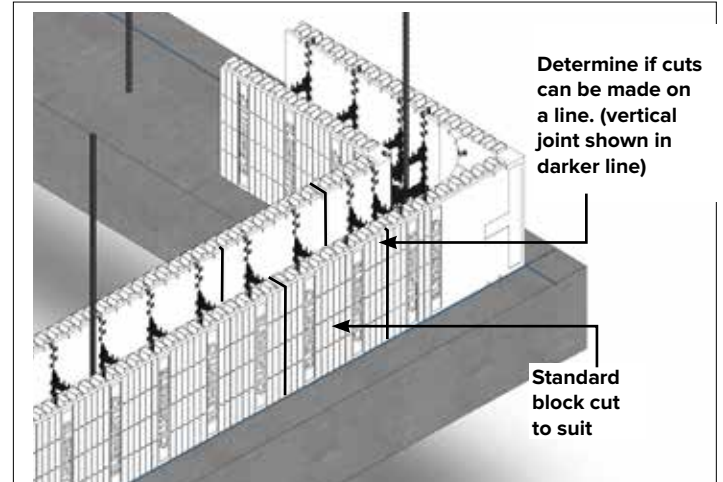

**STEP 5:** Cut a Standard block to fit the space left between the corner and the previous Standard block.

At this point, determine if adjustments are needed to the building dimensions so the cut can be made on a line. If adjustments are needed, alter chalk lines accordingly.

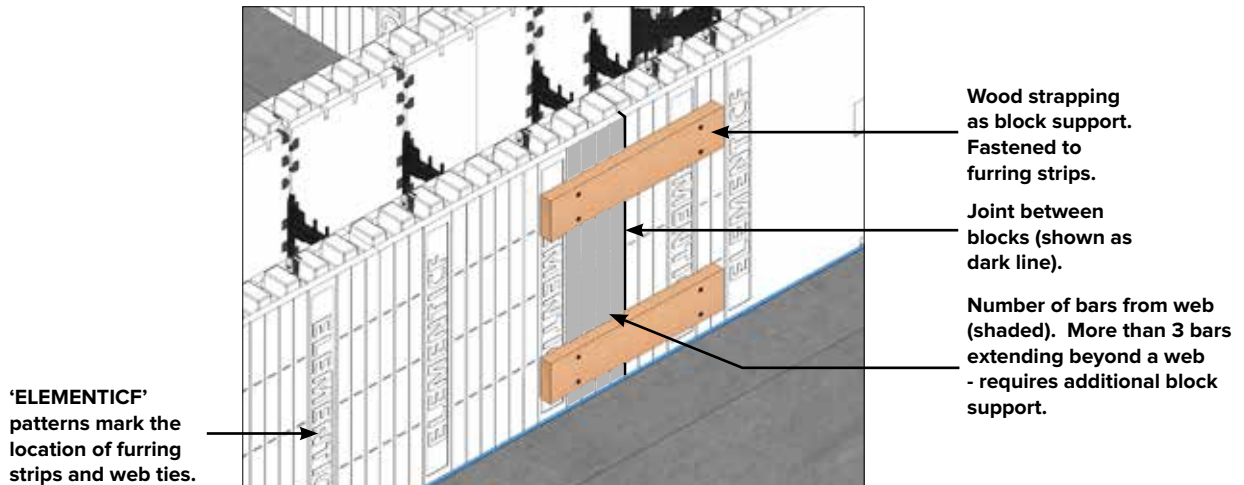

If more than 3 bars are extending beyond any web, additional block support is required on both faces of the block.

**STEP 6:** Continue around the wall in this manner until the first course is complete and dimensions are verified.

Leave the first course of blocks in place across door openings and low windows until blocks have been placed and building dimensions have been verified to maintain the interlock pattern above openings.





STEP 7: Place necessary rebar in first course as specified and according to local code.

NOTE: Web ties are designed with 'rebar slots' to provide secure placement of horizontal rebar, and allows for non-contact lap splices. See "2.9.2 – HORIZONTAL & VERTICAL REINFORCEMENT" on page 37.

STEP 8: Prior to starting the second course, install additional block support if required.



Place reinforcement and necessary additional block support prior to installing the second course.

### 2.8.2 – THE SECOND COURSE

STEP 1: Starting at the original corner, place appropriate corner block. When possible, alternate between left- and right-hand corners between courses. The blocks are reversible so flipping the blocks over for every course will alternate the orientation of the corner blocks and create a 16" offset.

NOTE: It is necessary to firmly seat every block to the block below to minimize interlock settling. The zip tabs at the top and bottom of each block, and interlock system, is designed to secure blocks between courses, which helps minimize block settling and movement during installation and concrete placement.

STEP 2: Continue placing blocks around the wall, working in the same direction as the first course. Make sure to secure blocks end-to-end with zip ties, Element Hooks or foam adhesive.

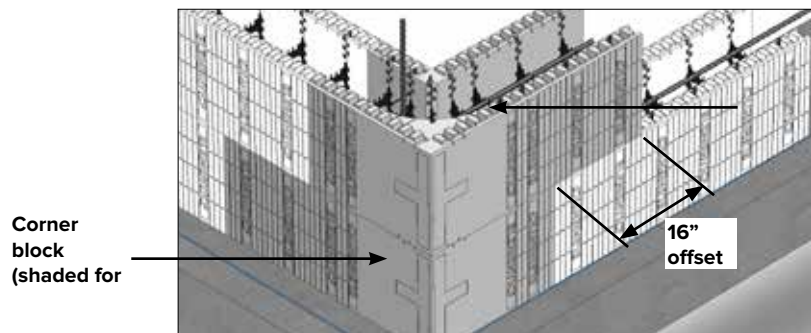

Flip the corner blocks to alternate between left and right-hand orientation between courses (shaded for clarity)

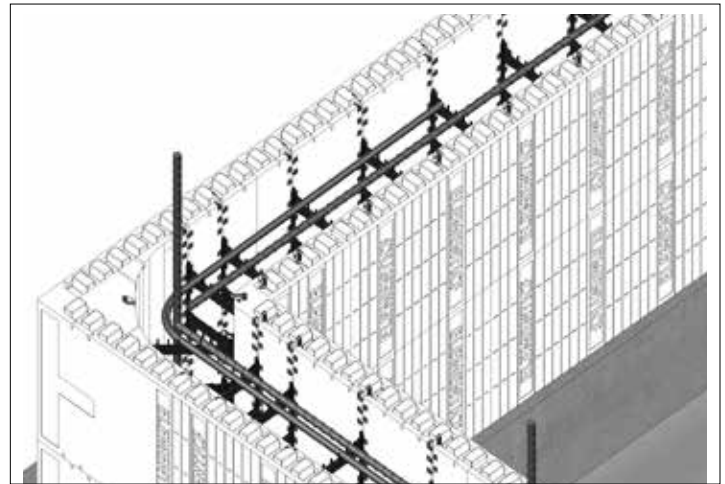
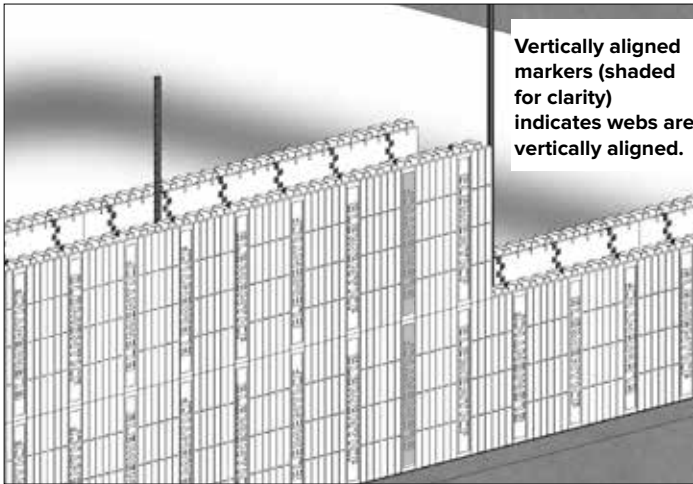

**STEP 3:** All webs should line up vertically, except where building dimensions are other than 8 inch (203 mm) increments. In this case, special cuts may be required to allow vertical alignment of webs. Webs are aligned when markers on the face of the block are vertically aligned.

**STEP 4:** Place necessary rebar after completion of second course.

**NOTE:** Web ties are designed with 'rebar slots' to provide secure placement of horizontal rebar, and allows for non-contact lap splices.

STEP 7: Use foam adhesive to fasten the straightened and leveled wall to the footing or slab. Insert the nozzle 1 inch (25 mm) at the base of every other web along the chalk line, and shimmed and trimmed locations, and inject foam between the block and the footing.

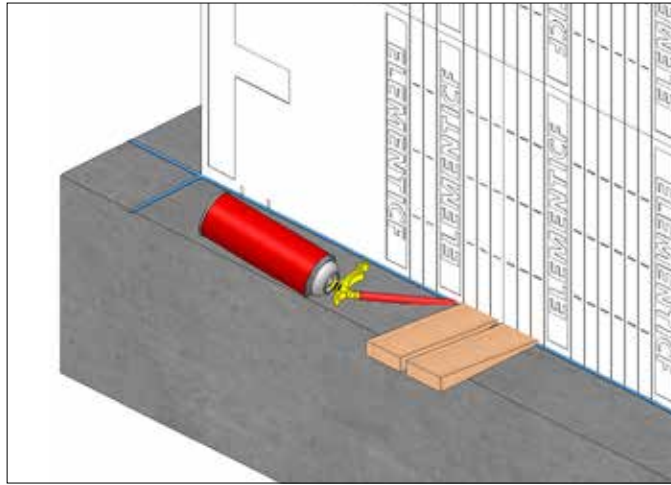

When vertical joints are less than 8 inches (203 mm) apart, additional block support is required.

It is important to note that at this point the wall pattern has been established. Course number 1 will be the pattern for all odd numbered courses (3, 5, 7, etc.). Course number 2 will be the pattern for all even numbered courses.

Wall alignment system to be installed at some point between the second and fourth courses, at no more than 7 feet (2.134 m) intervals. See “2.12 – WALL BRACING & ALIGNMENT SYSTEM” on page 56.

### 2.8.3 – ADDITIONAL COURSES

Installation of additional courses is generally the same as the second course, described in the previous section.

**STEP 1:** Fasten every corner end-to-end to adjoining blocks using zip ties, Element hooks, or adhesive foam.

Install Form Lock, if desired, every fourth or fifth course after the second course.

**STEP 2:** After completion of each course, place necessary rebar as specified and according to local code.

**STEP 3:** Secure blocks end-to-end in the top course to maintain building dimensions.

**STEP 4:** Secure the top course to the blocks below on both sides to prevent tipping during concrete placement.

INSTALLATION GUIDE - ELEMENT WALL CONSTRUCTION

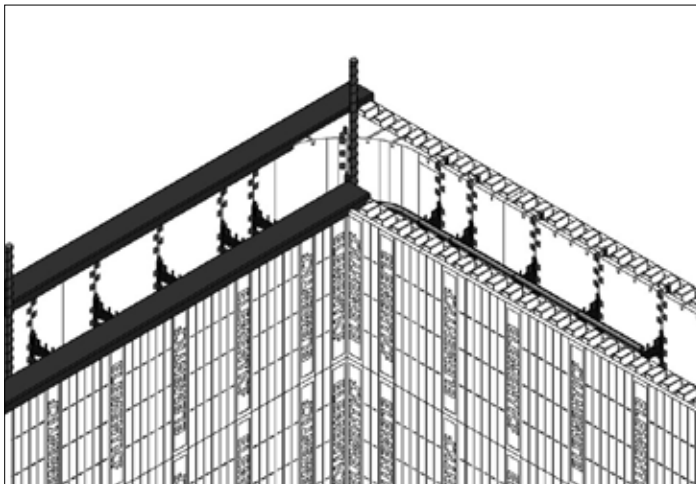

**STEP 5:** If additional stories are planned, the interlock needs to be protected prior to concrete placement.

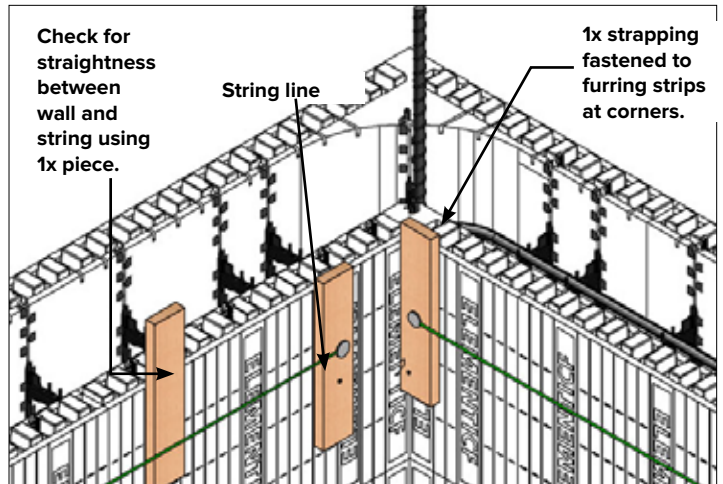

**STEP 6:** Check building dimensions. Check corners for plumb.

Ensure straight walls by placing a string at the top course set off from the wall using 3/4 inch pieces of wood placed in the corners. Check for straightness by running another 3/4 inch piece of wood between the string and wall.



## 2.8.4 – COURSE HEIGHTS

Element walls will primarily utilize 16-inch tall blocks. However, to efficiently match design wall heights with minimal cutting, Element blocks are also offered in 4 and 8 inch heights with Height Adjusters and Half-Height blocks, respectively. This flexibility enables constructing Element wall heights in increments as small as 4 inches.

Additionally, 16 inch tall blocks can be cut down to 4, 8 or 12 inch tall blocks by following the cut lines marked on the block panels.

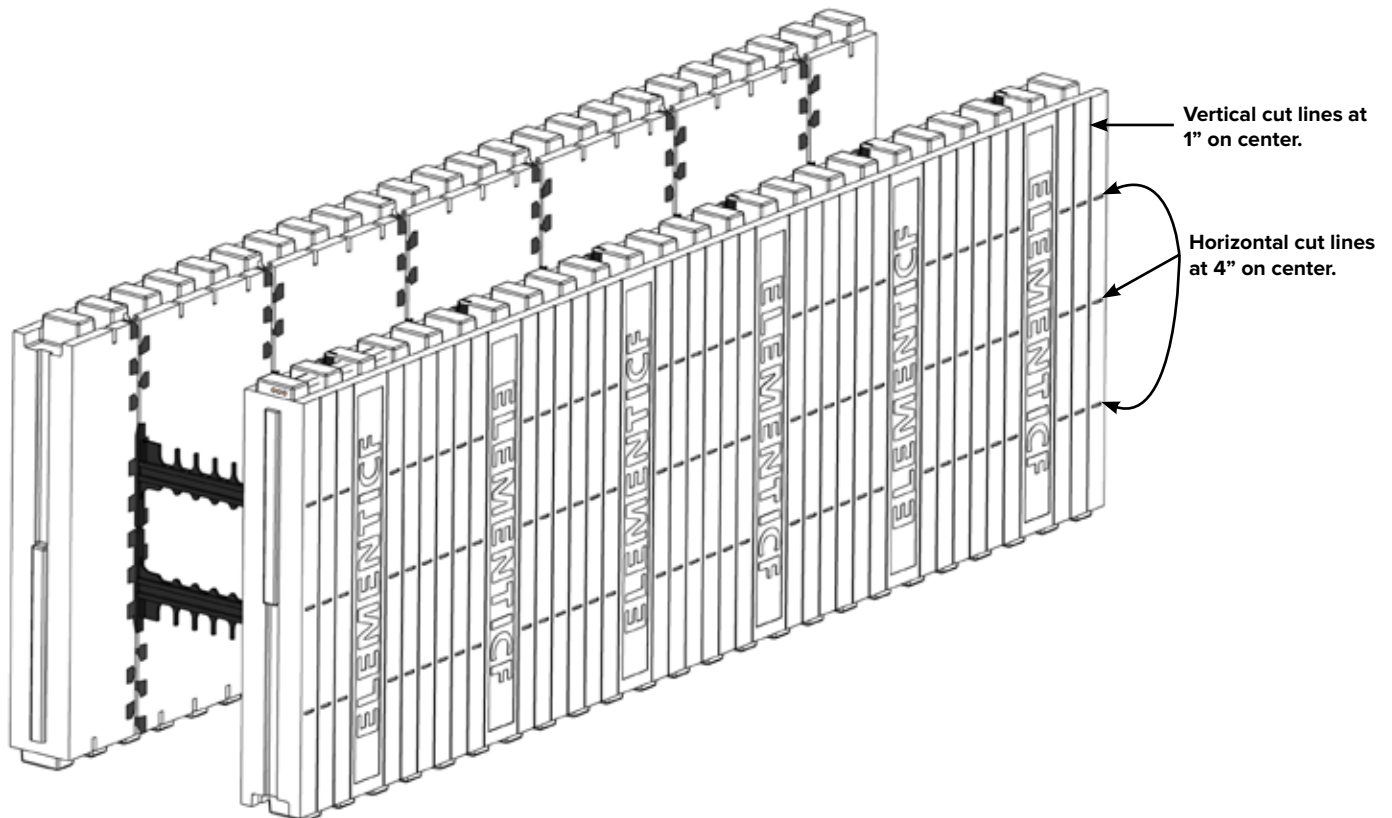

Element Standard 16" tall blocks are equipped with cut lines for faster cutting on site.

### 2.8.4.1 – HEIGHT ADJUSTERS WITH SITE-ASSEMBLED BLOCKS

Element Height Adjusters are 4 inch tall by 4 feet long x 2.75 inch thick panels and can be used with both Preformed and Site-assembled blocks. While not depicted in the following illustrations, it is recommended to offset the vertical joints of the Height Adjusters with the courses above and below for best practice.

INSTALLATION GUIDE - ELEMENT WALL CONSTRUCTION

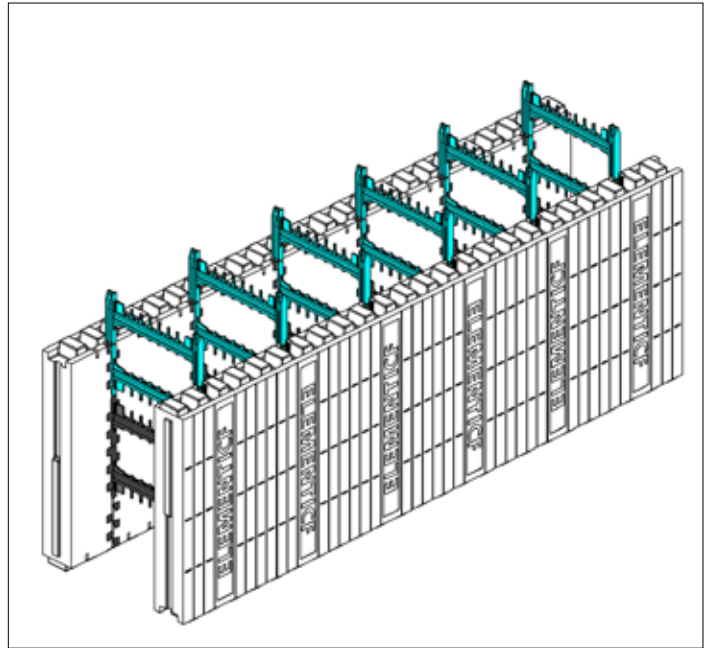
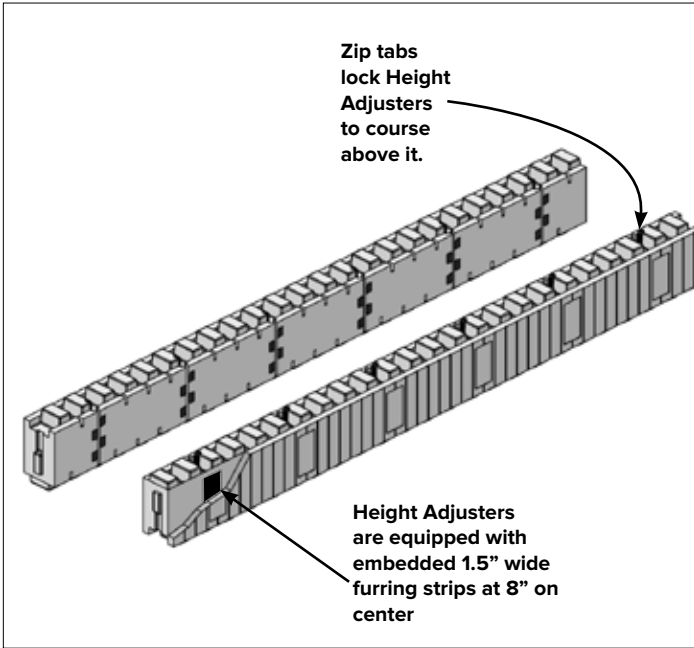

STEP 1: Insert Flexities (shown in blue for clarity).

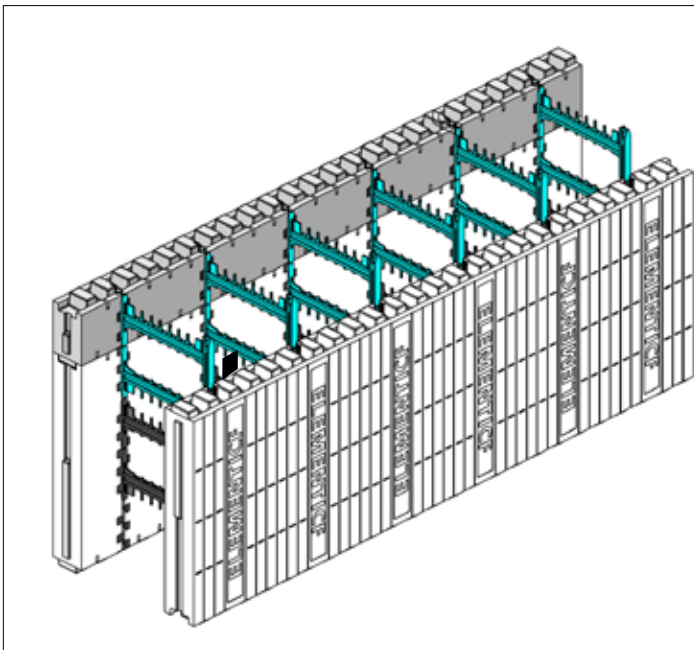

STEP 2: Place the Height Adjusters.

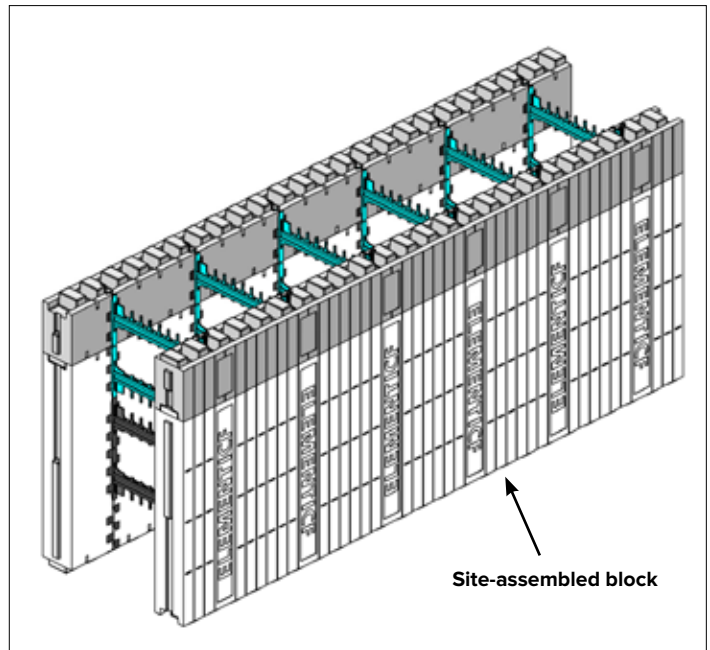

Completed assembly of Height Adjusters with Site-assembled block.

2.8.4.2 – HEIGHT ADJUSTERS WITH PREFORMED BLOCKS

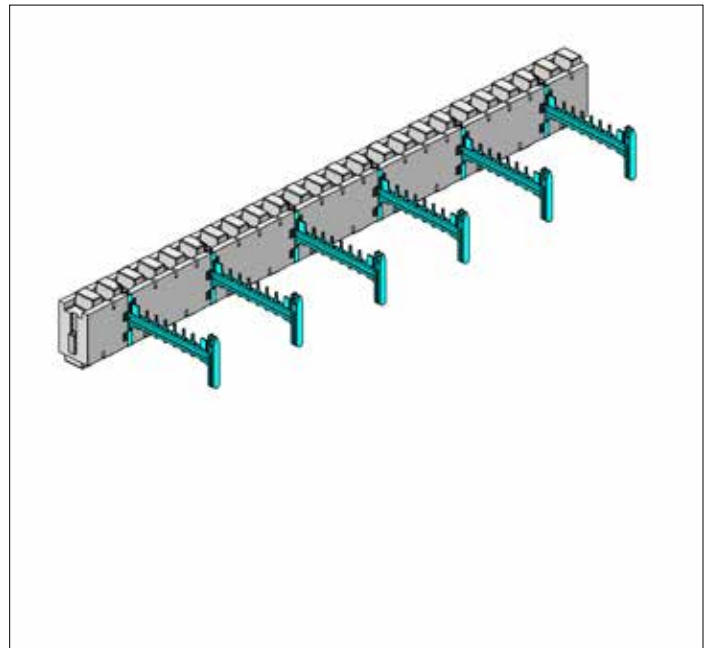
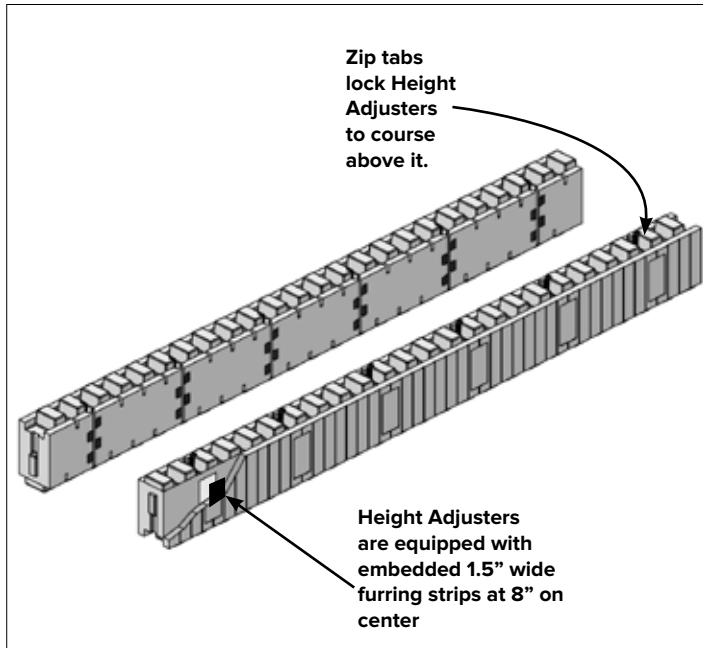

STEP 1: Insert Flexities snapped in half (shown in blue for clarity).

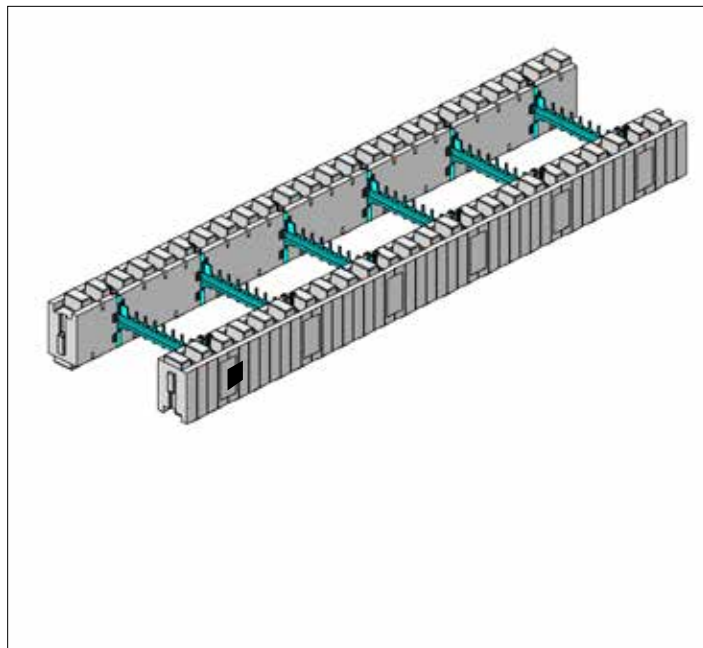

STEP 2: Place the Height Adjusters.

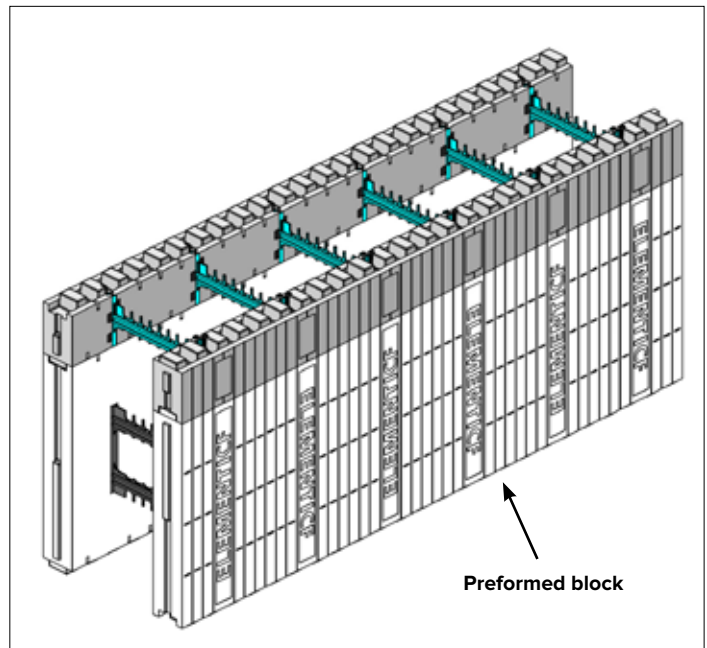

Completed assembly of Height Adjusters with Preformed blocks.

**2.8.4.3 – HALF-HEIGHTS**

Half-height blocks can be fabricated on-site from both Preformed and Site-assembled blocks. With Preformed blocks, simply cut along the center cut line of a 16-inch tall block to create two Half-height blocks. Below is the procedure to create two half-height blocks using a site-assembled block, and six additional flexties.

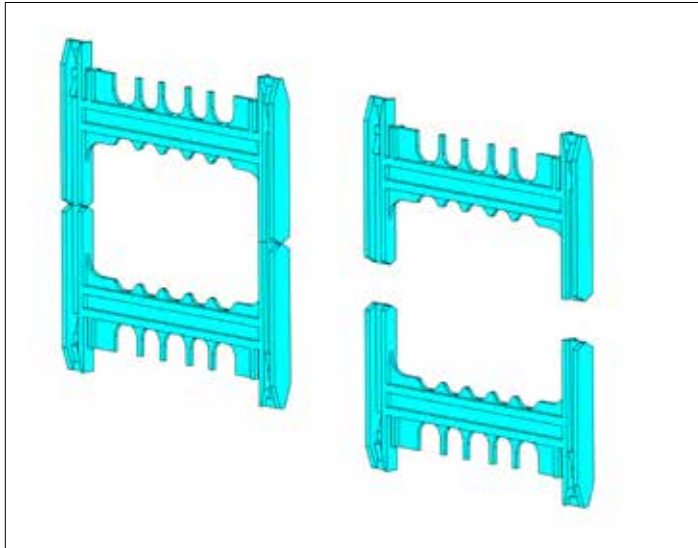

STEP 1: Snap Flexties in half (shown in blue for clarity).

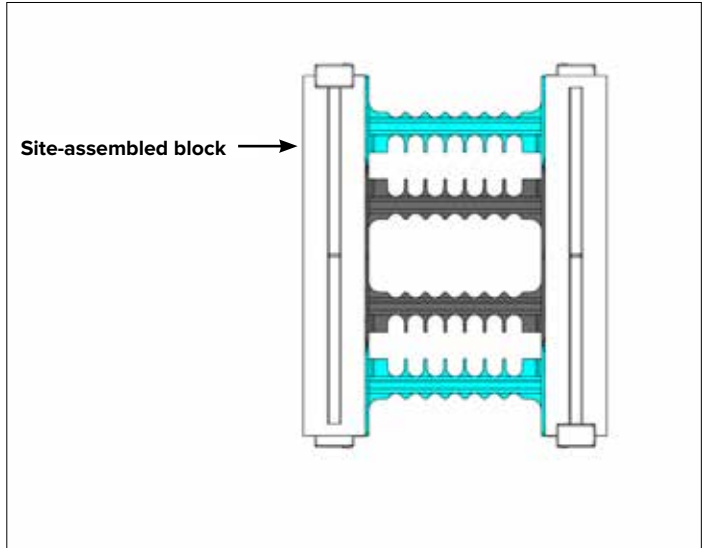

STEP 2: Slide the snapped Flexties into the top and bottom of the Site-assembled block.

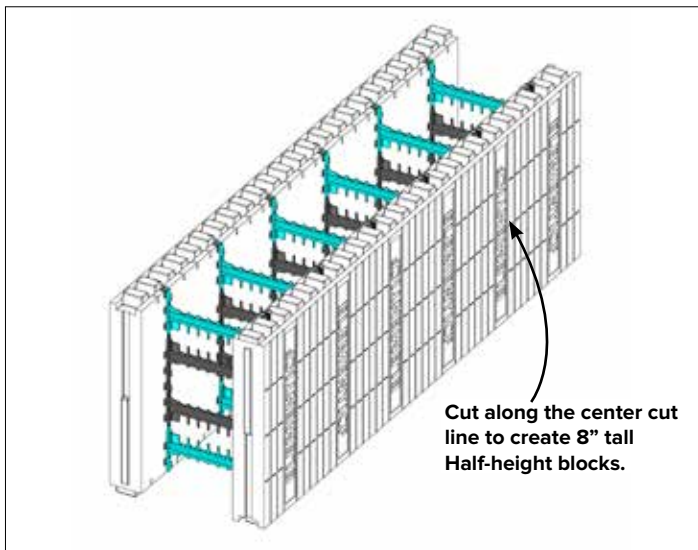

STEP 3: Cut the block in half.

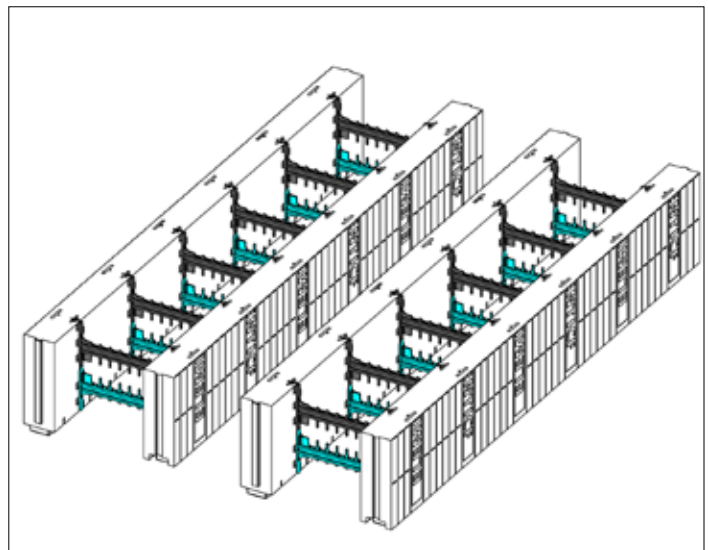

STEP 4: Two Half-height blocks are produced.

INSTALLATION GUIDE - ELEMENT WALL CONSTRUCTION





Alternatively, half-height blocks can be made with Height Adjusters.

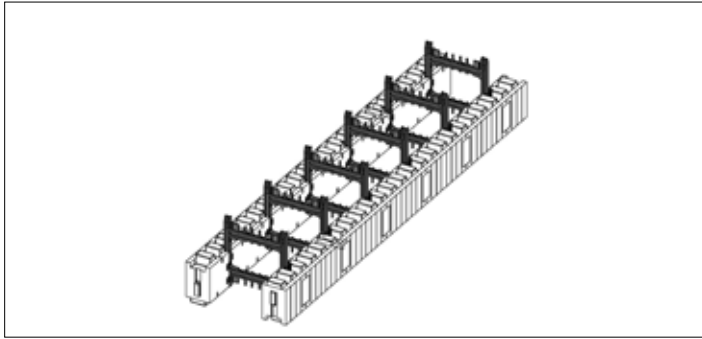

STEP 1: Insert Flexties into the Height Adjusters.

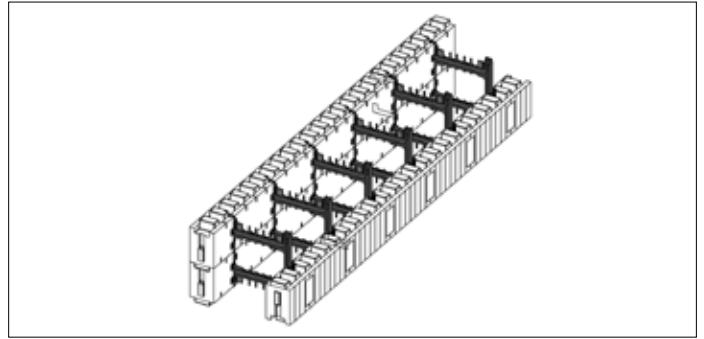

STEP 2: Slide additional Height Adjusters in place.

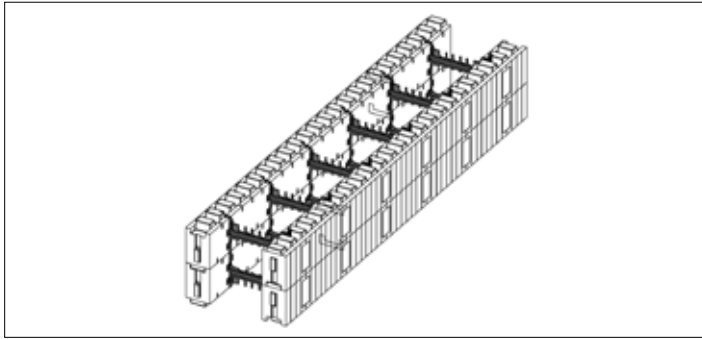

Half-Height blocks assembled from Height Adjusters.

## 2.8.5 – CORNER BRICK LEDGE AND TAPER TOPS

Brick Ledge and Taper Top blocks come only in straight units, so mitered cuts on site must be made to create corners with these blocks. Mitre cuts can be made freehand or with a template.

### 2.8.5.1 – BRICK LEDGE CORNERS

Making a mitre when a Brick Ledge block is at least one web and 4.5 bars beyond the corner block will ensure the webs align vertically between courses. Extending at least two webs and 4.5 bars and making the cut will create a remaining piece that can be used for an inside corner elsewhere in the layout.

INSTALLATION GUIDE - ELEMENT WALL CONSTRUCTION

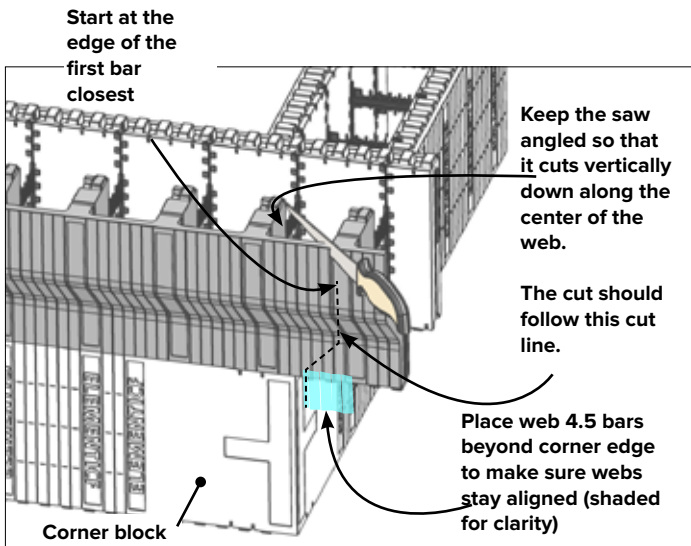

STEP 1: With the first Brick Ledge block, make a miter cut on the Brick Ledge panel.

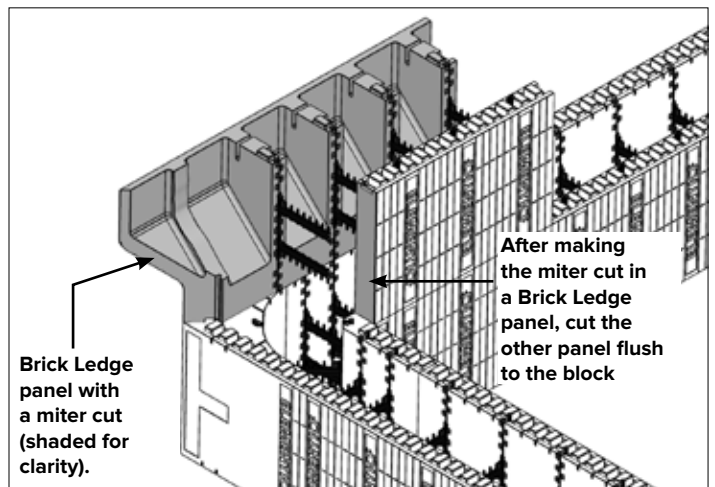

STEP 2: With the first Brick Ledge block, make a butt-joint cut flush to the block below.

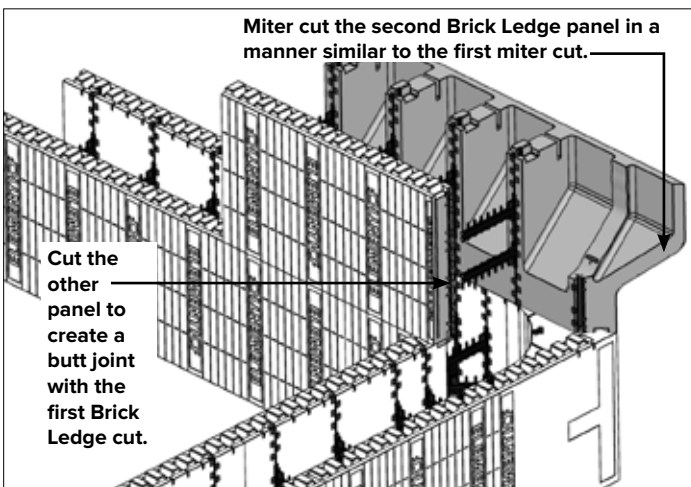

STEP 3: With the second Brick Ledge block, make similar miter and butt-joint cuts.

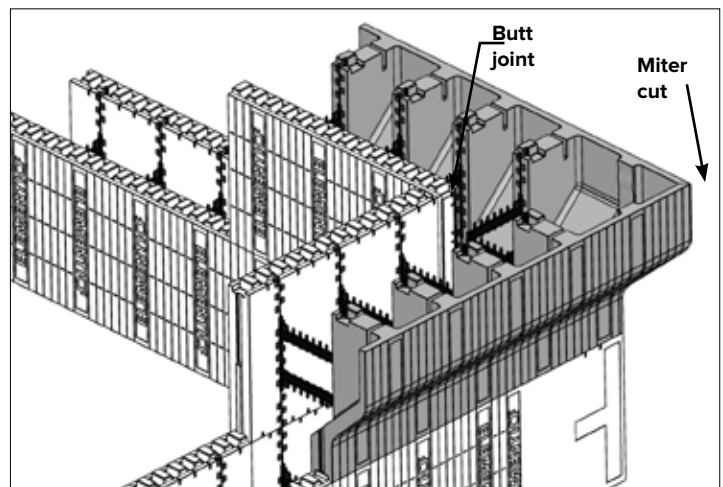

STEP 4: Place both cut Brick Ledge blocks to create the Brick Ledge 90° corner.

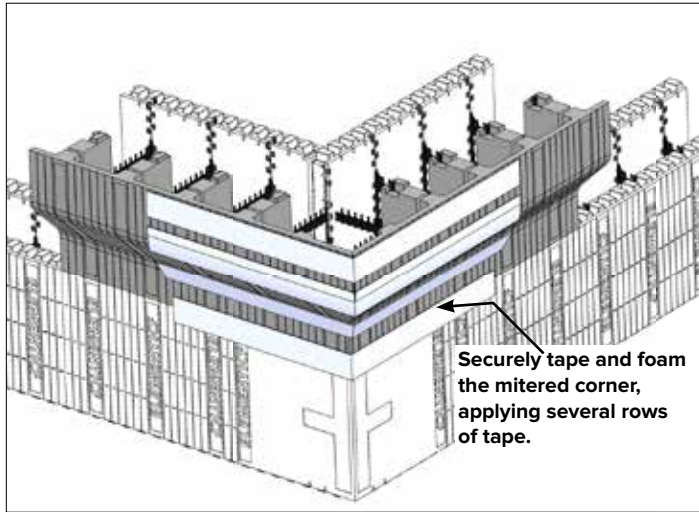

Securely tape and foam the mitered corner, applying several rows of tape.

STEP 5: Secure the corner Brick Ledge with tape and foam.

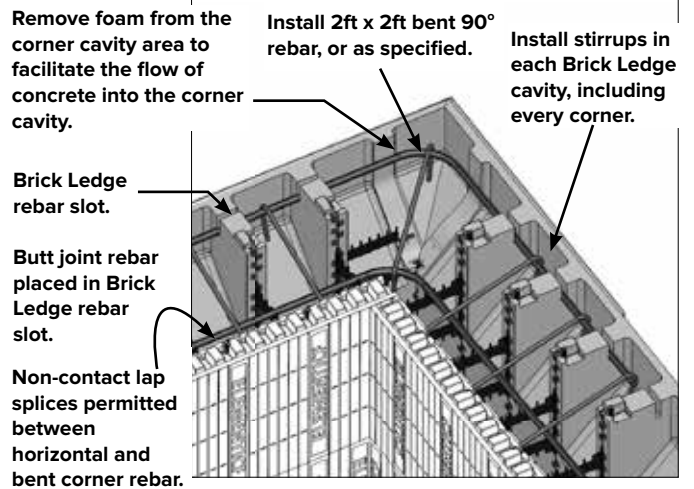

Remove foam from the corner cavity area to facilitate the flow of concrete into the corner

Install 2ft x 2ft bent 90° rebar, or as specified.

Install stirrups in each Brick Ledge cavity, including every corner.

Brick Ledge rebar slot.

Butt joint rebar placed in Brick Ledge rebar slot.

Non-contact lap splices permitted between horizontal and bent corner rebar.

STEP 6: Place rebar, as required, and remove foam from cavity where necessary.

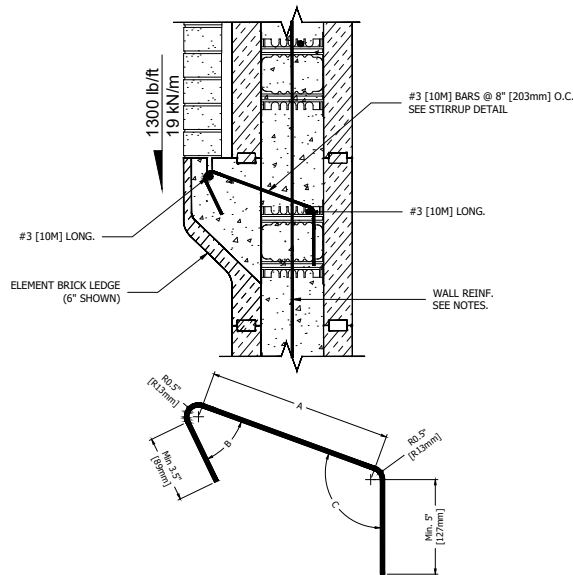

STIRRUP DETAILS  
(Refer to Element Brick Ledge Stirrup Dimensions Table)

	BRICK LEDGE SIZE				
	4"	6"	8"	10"	12"
A	8" [203mm]	9.7" [246mm]	11.6" [295mm]	13.4" [340mm]	15.25" [387mm]
B	40°	44°	48°	50°	52°
C	115°	110°	106°	104°	103°

Standard Brick Ledge reinforcement shown. For heavier reinforcement see "2.19.8 – BRICK VENEER" on page 86

**2.8.5.2 – CORNER TAPER TOP FROM MITRE CUTS**

Just like Brick Ledge, Taper Top blocks come only in straight units, so mitered cuts on site must be made to create corners with these blocks. Or alternatively, Taper Top corners can be made with Standard corners.

Making a mitre when a Brick Ledge block is at least one web and 4.5 bars beyond the corner block will ensure the webs align vertically between courses.

INSTALLATION GUIDE - ELEMENT WALL CONSTRUCTION

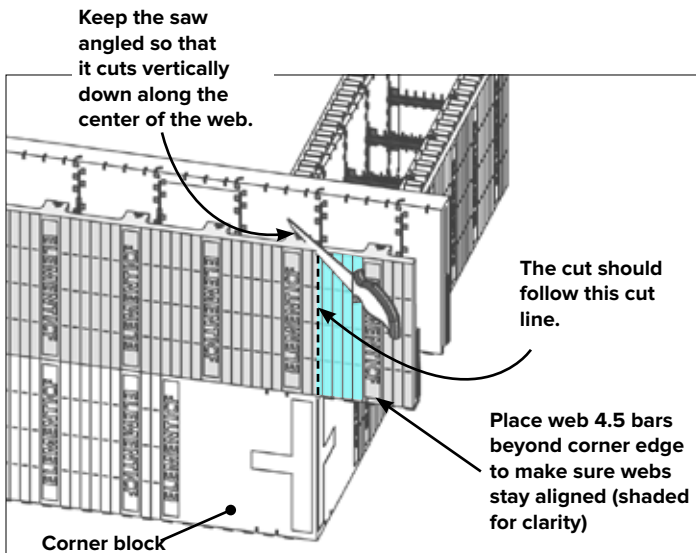

**STEP 1:** With the first Taper Top block, make a miter cut on the Taper Top panel.

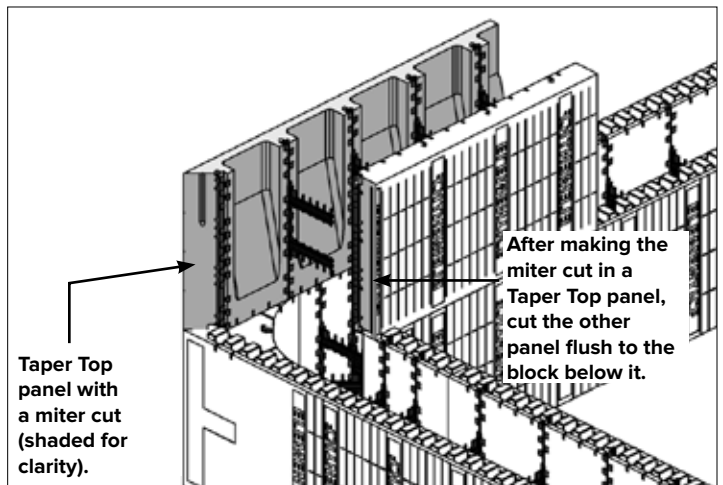

**STEP 2:** With the first Taper Top block, make a butt-joint cut flush to the block below.

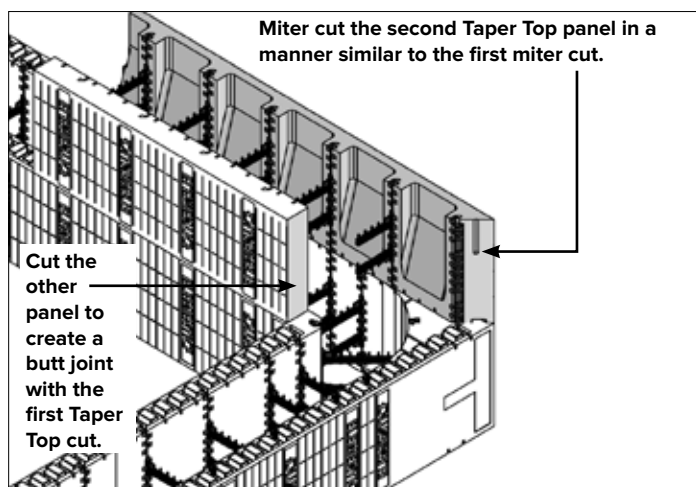

**STEP 3:** With the second Taper Top block, make similar miter and butt-joint cuts.

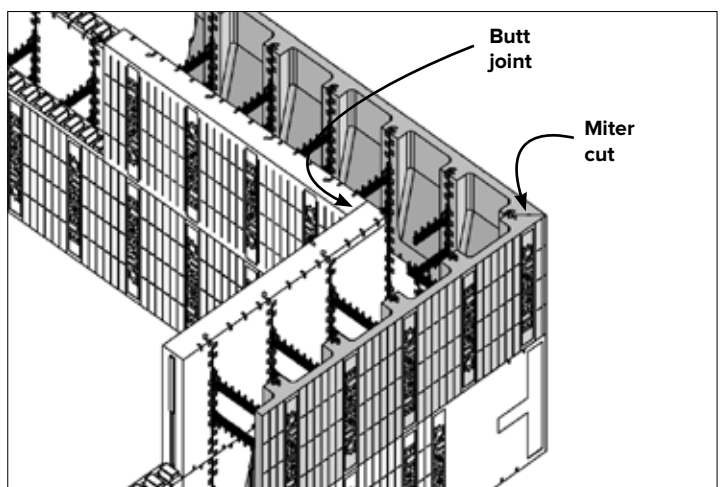

**STEP 4:** Place both cut Taper Top blocks to create the Taper Top 90° corner.

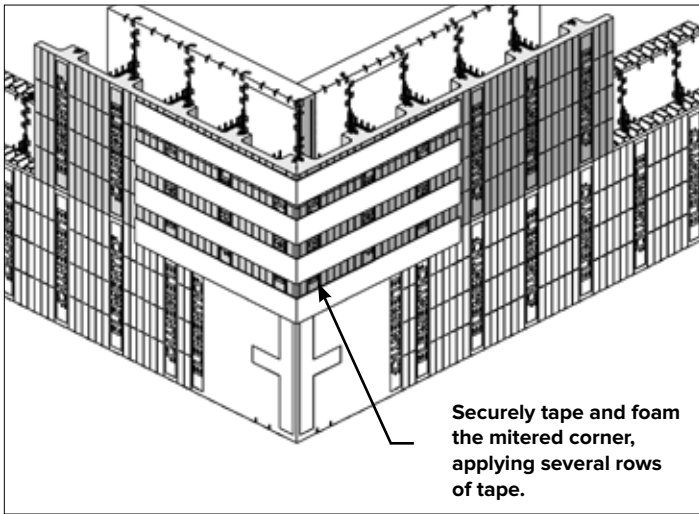

STEP 5: Secure the corner Taper Top with tape and foam.

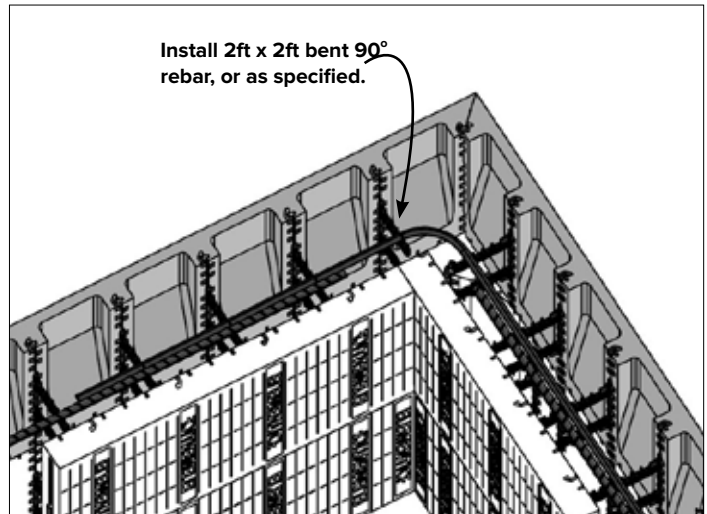

STEP 6: Place rebar, as required.

**2.8.5.3 – CORNER TAPER TOP FROM STANDARD CORNERS**

Taper Top corners can be made with Standard Corner blocks. This would require carving out the excess foam in the Standard Corners to create the tapered profile. To avoid dropping discarded foam into the ICF wall cavity, remove excess foam prior to installing in place.

INSTALLATION GUIDE - ELEMENT WALL CONSTRUCTION

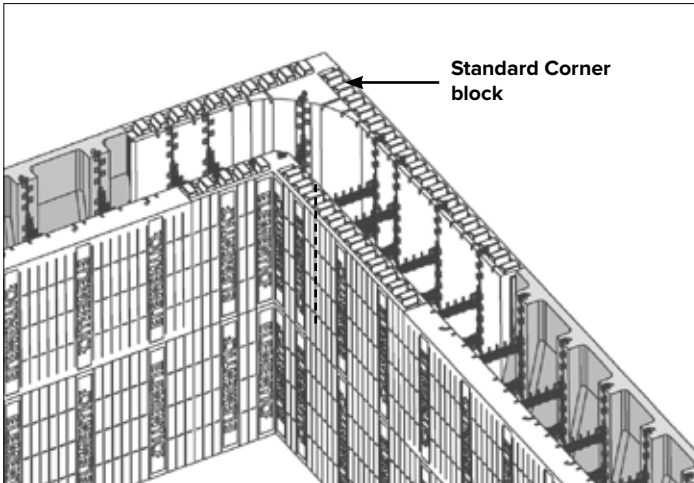

**STEP 1:** A Standard Corner block can be used at the corners.

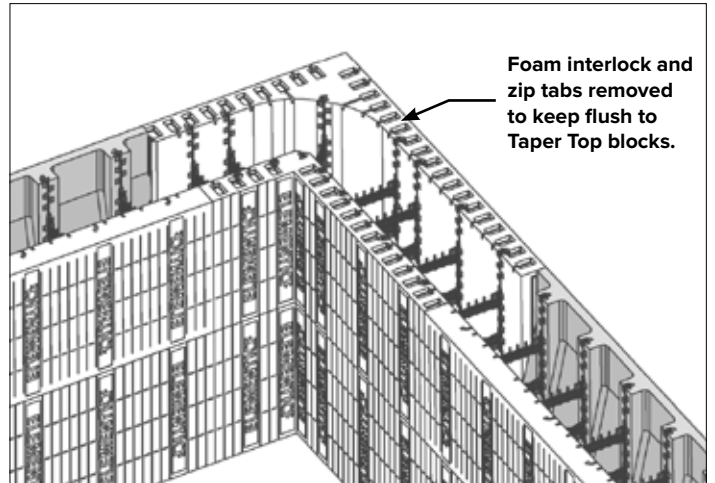

**STEP 2:** Remove interlock and zip tabs.

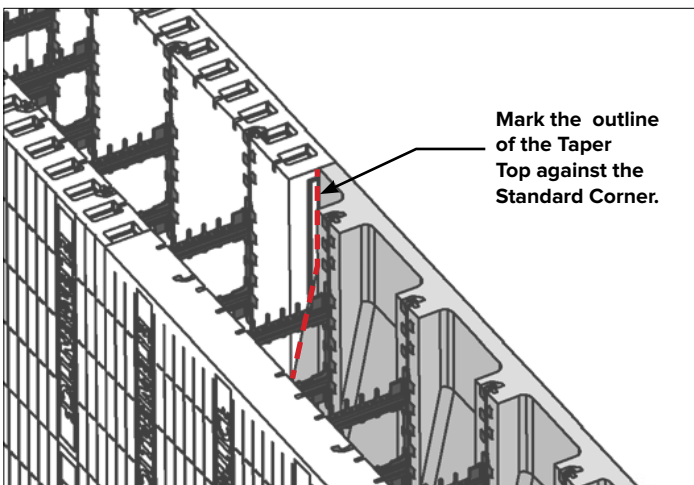

**STEP 3:** Trace the outline of the Taper Top side profile against the Standard Corner block.

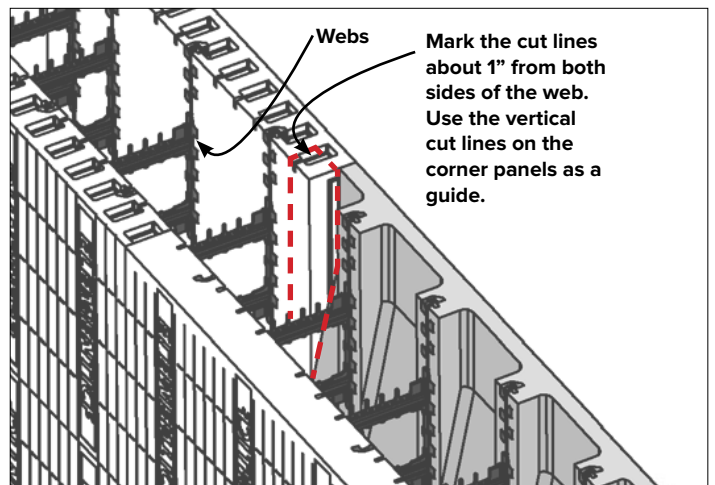

**STEP 4:** Mark the Standard Corner block to match the Taper Top top profile between all the webs.

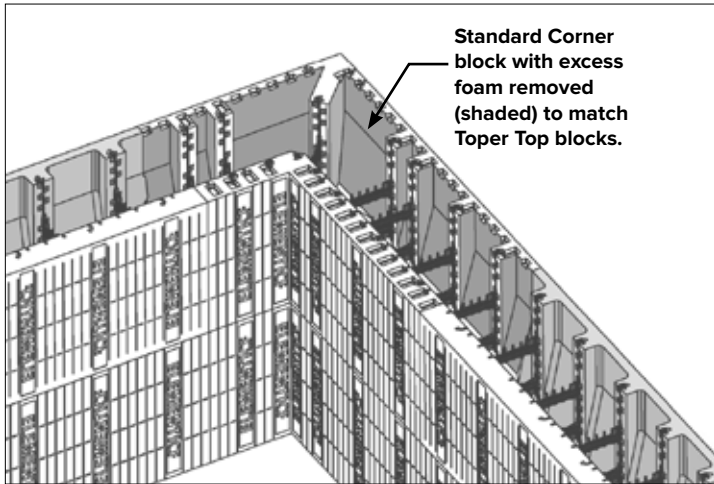

STEP 5: Cut the foam following the cut lines prior to installing in place with a drywall or pruning saw.

### 2.8.6 – TEE WALLS

Wall T-junctions can be constructed by field-cutting Element Standard blocks.

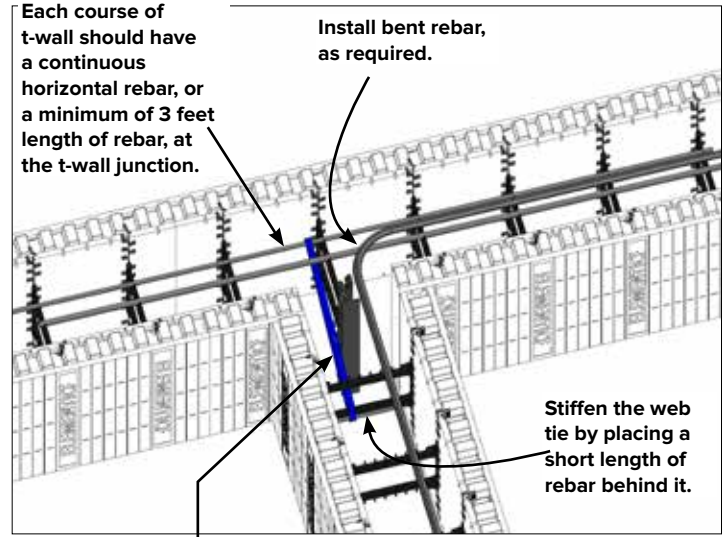
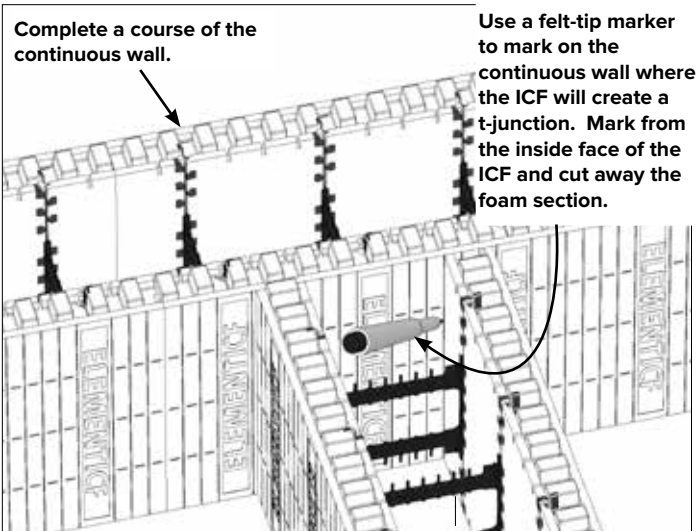

For each course use a zip tie or tie wire to support the ICF at the t-junction. Wrap the zip tie or tie wire around the horizontal rebar and to the Flex tie closest to the t-junction.

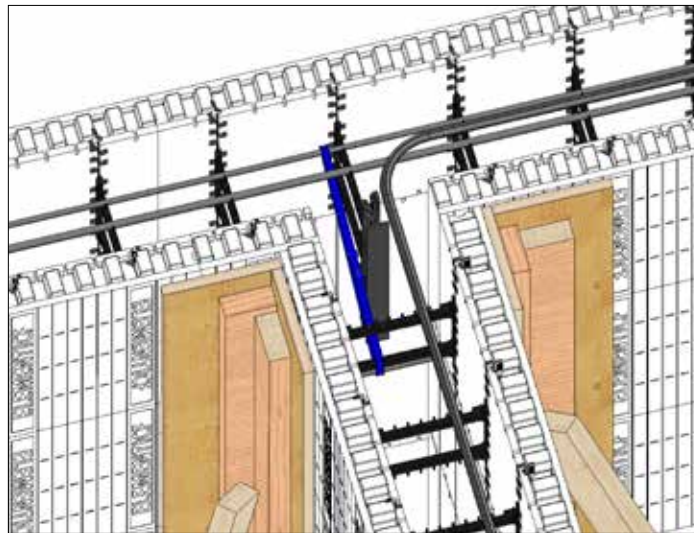

Another option for building a t-wall is to construct the entire continuous wall first. This method requires pre-planning to ensure there is adequate reinforcement at every course to allow the t-wall to be attached securely. All other steps above need to be applied.

INSTALLATION GUIDE - ELEMENT WALL CONSTRUCTION



**2.8.7 – GABLE WALLS**

The preferred method to construct a gable end is on the floor to be installed as a one-piece unit.

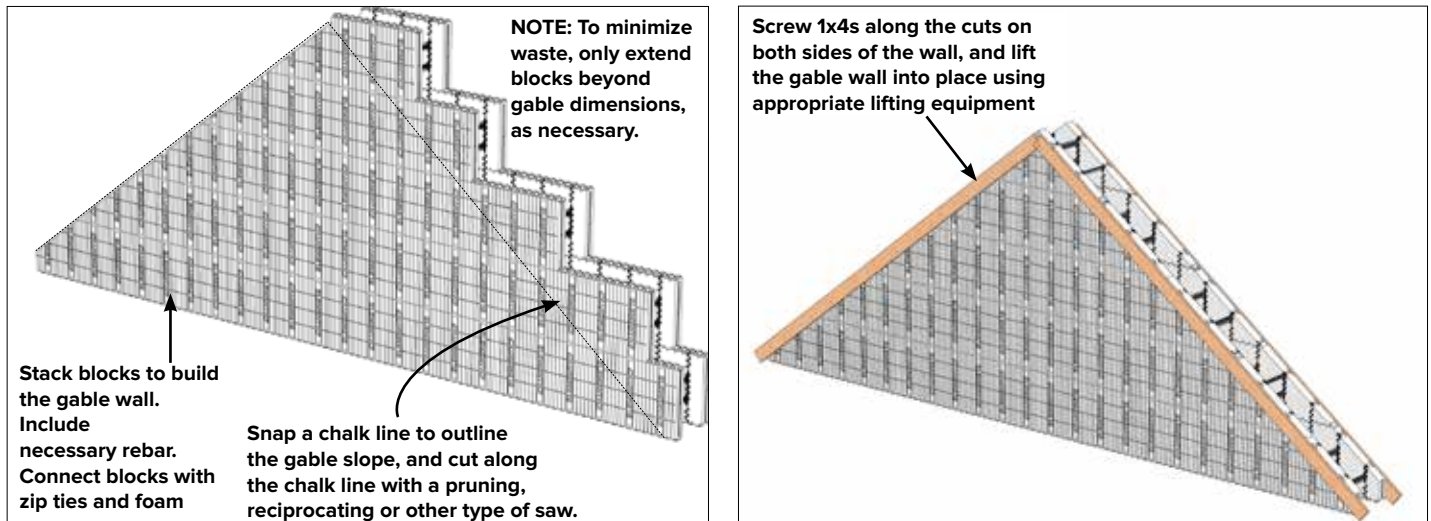

Make sure all necessary roof attachment hardware is available prior to concrete placement, as it must be installed during or immediately after the pour.

**NOTE:** Pieces of plywood can be screwed into the 1x4s during placement to help contain the concrete.

Another option for constructing a gable wall is to assemble the gable in place. Set the pitch for the gable by marking the first course appropriately. Subsequent courses should follow this pattern.

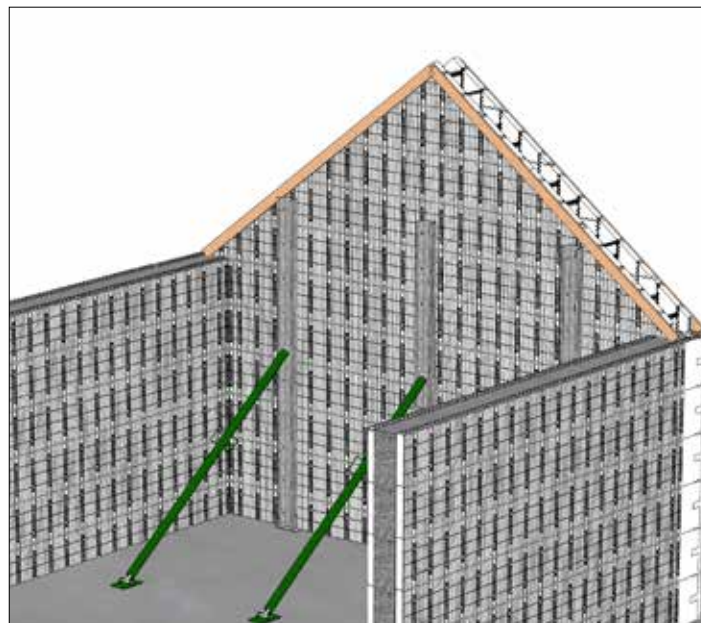

Prior to lifting the gable wall into place, ensure that appropriate wall alignments and scaffolding system is in place for safe installation.

### 2.8.8 – RADIUS WALLS

There are a number of different methods for creating radius walls with Element. Below, is a guide that will create radius walls based on 8 inch segments of Element.

NOTE: This process will result in vertically stacked joints, and additional block support will be required prior to concrete placement.

See “2.22 – RADIUS WALLS” on page 95, for radius wall tables.

INSTALLATION GUIDE - ELEMENT WALL CONSTRUCTION

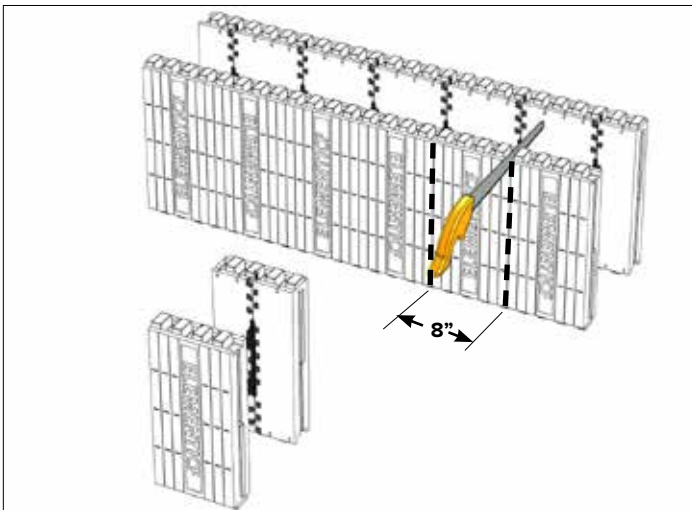

STEP 1: Cut blocks into 8” sections with web centered in each section.

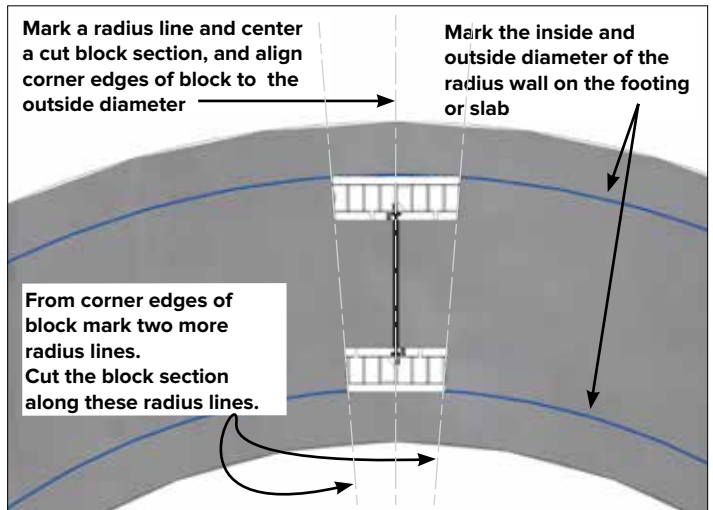

STEP 2: Mark radius lines for an 8” cut section.

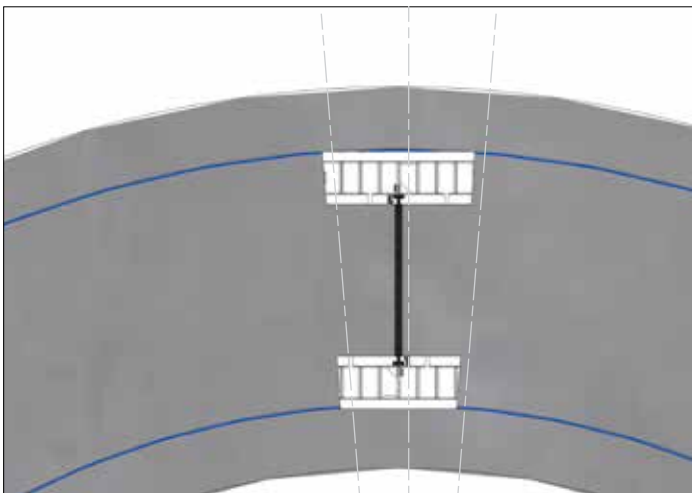

STEP 3: Cut the 8” section at the edges along the radius lines. Mark and cut all block sections using this template.

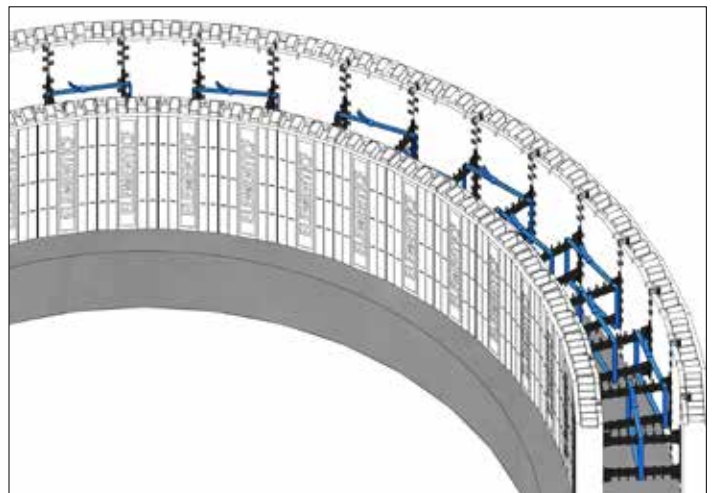

STEP 4: Connect and secure sections with zip-ties, tapes and foam to create the first course. Repeat the steps for each additional course, and connect each with zip ties or Element hooks.

**2.8.9 – ELEMENT XRV INSERT PANELS**

Element XRV™ Insert Panels are 2 inch thick foam panels that provide a quick and easy alternative to providing an increase in R-value of an ELEMENT WALL assembly.

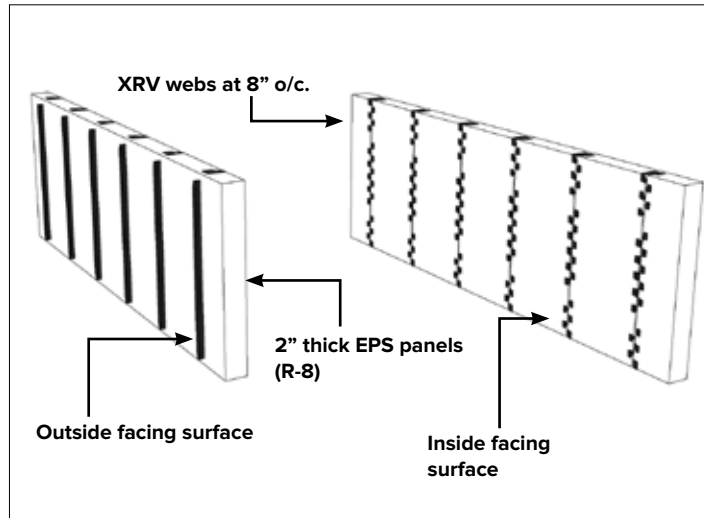

XRV Insert Panel.

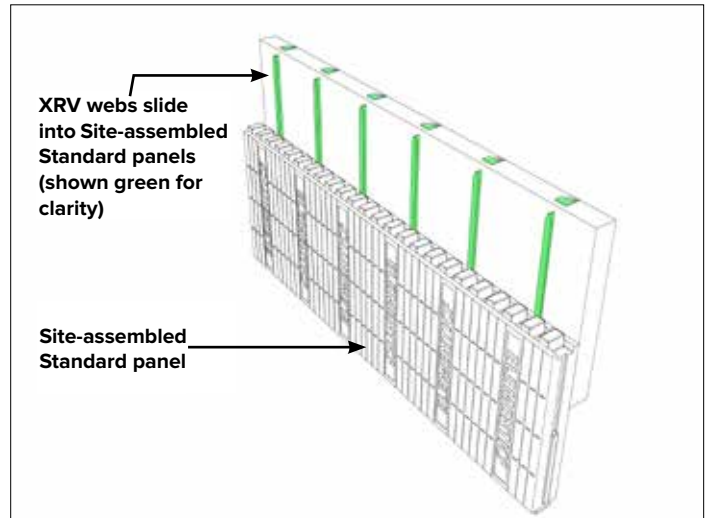

XRV panel connection to Standard Site-assemble panel.

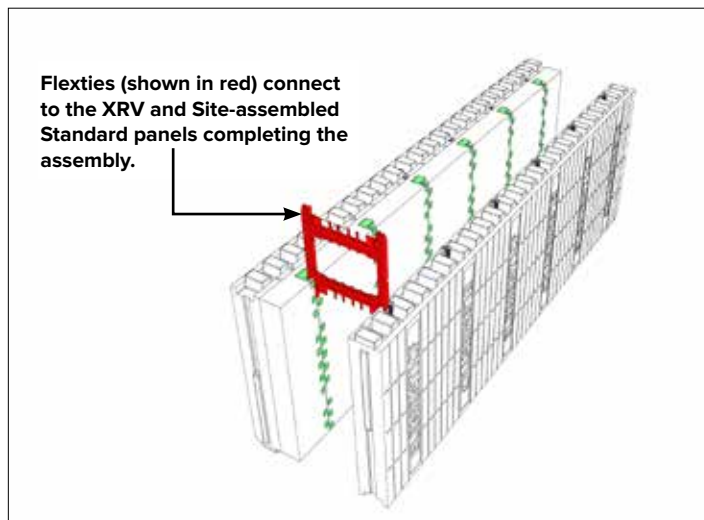

Additional XRV panels can connect to both XRV and Site-assembled Standard panels for progressively increasing R-values.

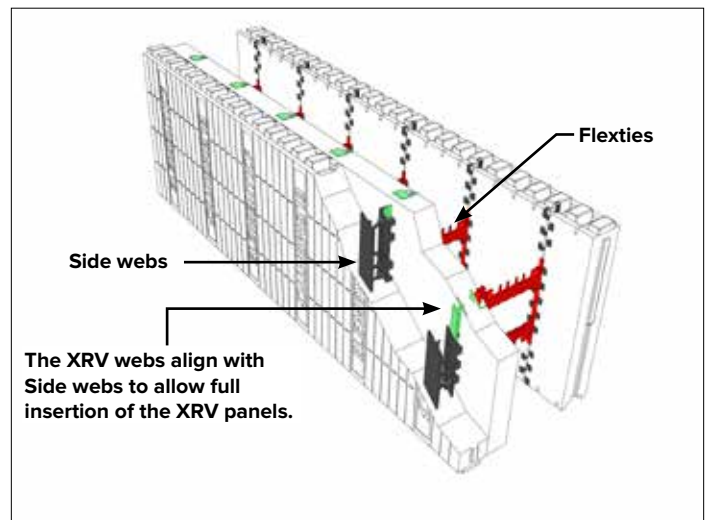

XRV panels snap and lock into place against the inside face of Standard Site-assembled blocks without the need for fasteners or adhesives.

XRV™ panels can be installed into the Element Site-assembled blocks either before or while the block blocks are stacked to build the wall.

Offsetting the vertical joints of the XRV™ panels with the vertical joints of the Element blocks will create a stronger, more rigid wall structure.

## 2.9 – REINFORCEMENT

Reinforcing steel (rebar) strengthens concrete walls to help minimize cracking and buckling under load.

It is the responsibility of the installer to verify rebar specifications to comply with local building codes and engineering specs.

Refer to the Element Prescriptive Engineering manual, and Section 5.14 for typical reinforcement details.

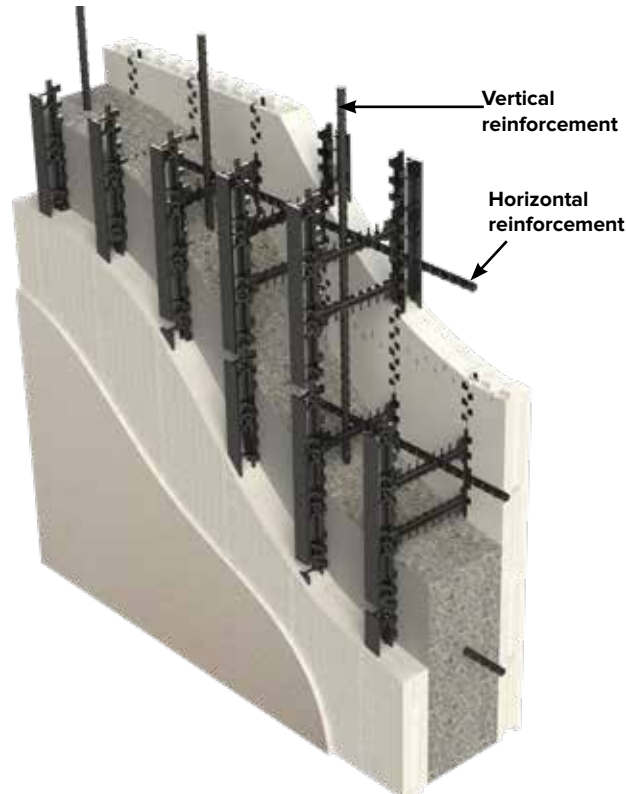

### 2.9.1 – BASIC REINFORCEMENT

- Reinforcing steel must meet the requirements of ASTM A615, ASTM A996, or ASTM A706 for low-alloy steel. Minimum of Grade 40 (300MPa).
- Reinforcing steel in an Element ICF wall must have minimum concrete cover outlined in the Element Prescriptive Engineering manual, or as specified by design.
- Hold the reinforcement back from door and window openings outlined in the Element Prescriptive Engineering manual, or as specified by design or local building codes.
- It is the responsibility of the installer to verify table rebar specifications with local building codes and engineering specs.

2.9.2 – HORIZONTAL & VERTICAL REINFORCEMENT

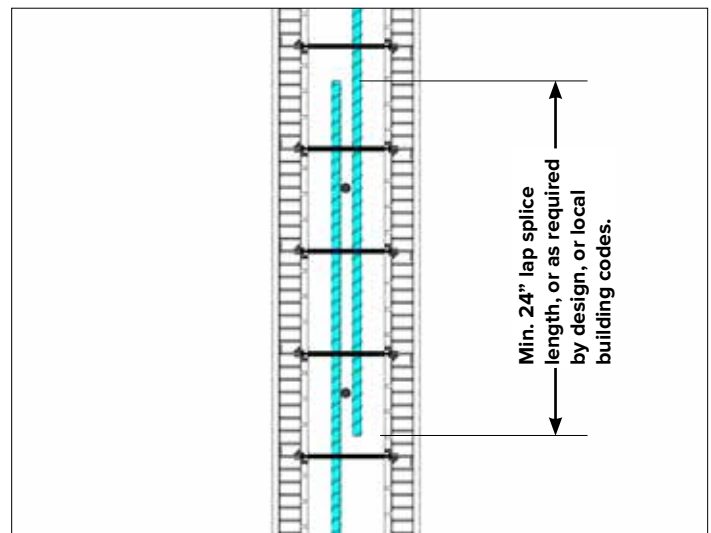
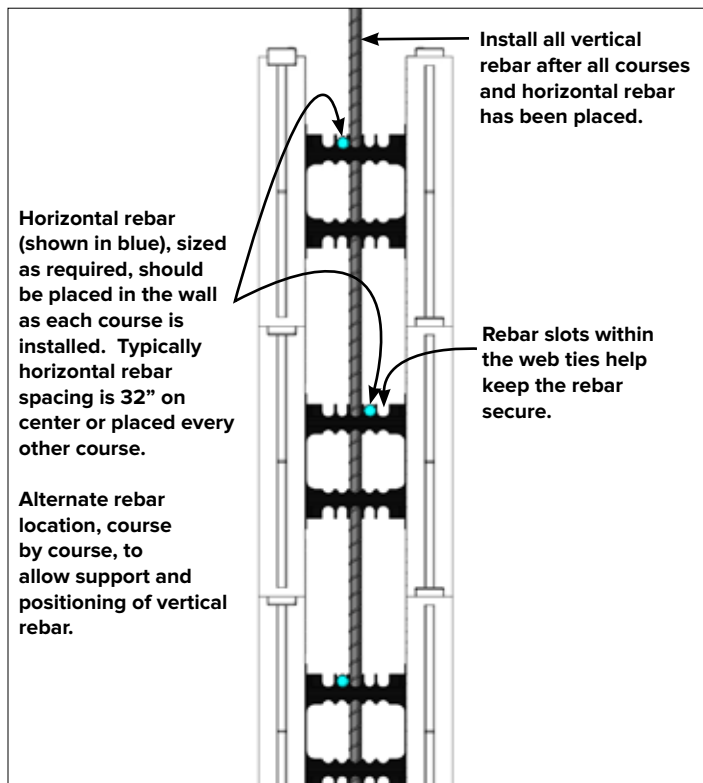

Rebar slots in the Side webs allow for non-contact lap splices of horizontal rebar, the preferred method when creating lap splices.

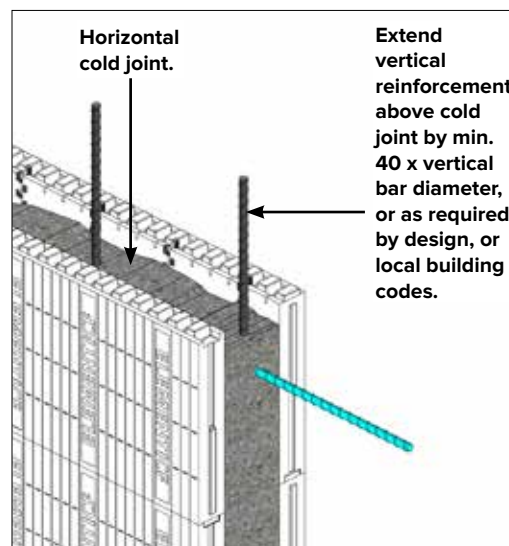

**2.9.3 – HORIZONTAL REBAR SPACINGS**

Horizontal rebar spacing is usually set at 16 or 18 inches vertically. However, if closer spacing is required, Element ICF can accommodate smaller intervals by incorporating extra Flexties as necessary. This flexibility in adjusting horizontal bar spacing offers several advantages, making it simpler to design and construct Element ICF walls for various purposes such as:

- safe rooms,
- shear walls,
- grade beams,
- bottom rebar closer to the footing or slab surface,
- or top rebar closer to the top of wall.

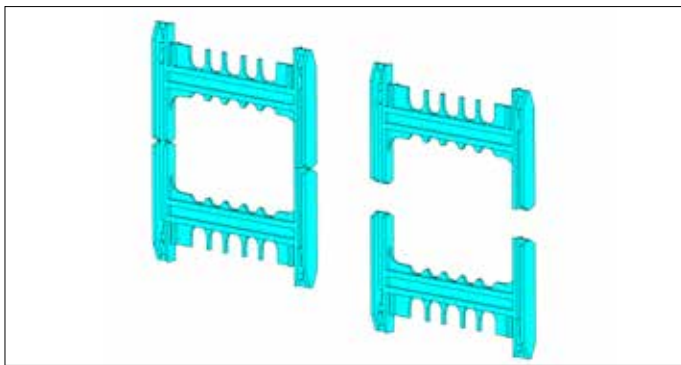

Snap Flexties in half.

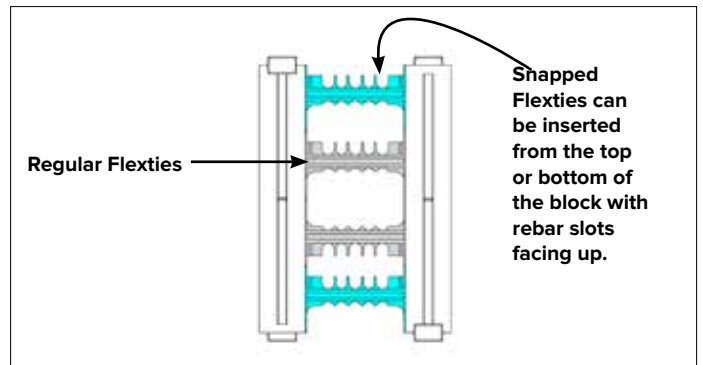

Flexties can be inserted into Site-assembled blocks.

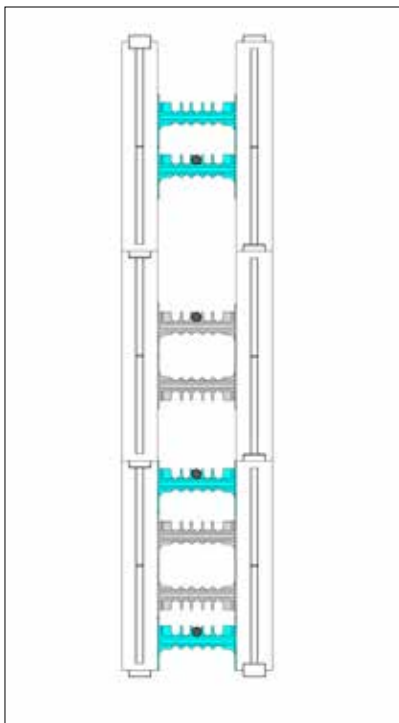

Snapped Flexties placed for 12" on center horizontal rebar spacing

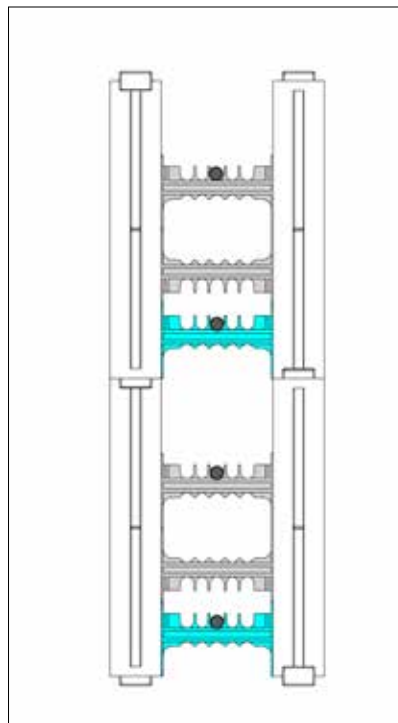

Snapped Flexties placed for 8" on center horizontal rebar spacing

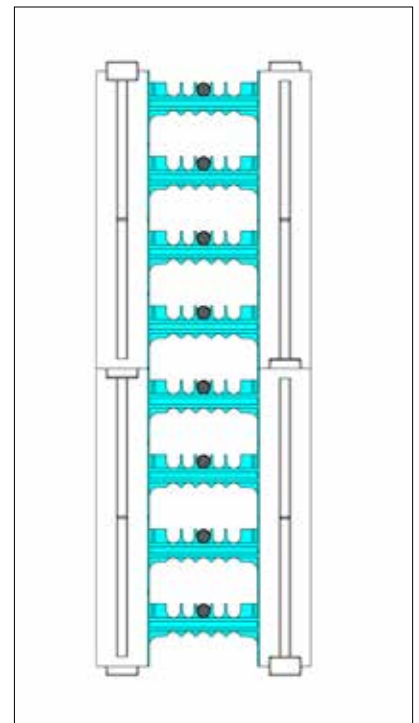

Snapped Flexties placed for 4" on center horizontal rebar spacing

INSTALLATION GUIDE - REINFORCEMENT

**2.9.4 – TYPICAL REINFORCEMENT AT OPENINGS**

Hold all reinforcement back 2 inches (51 mm) from door and window buck material to ensure proper concrete coverage.

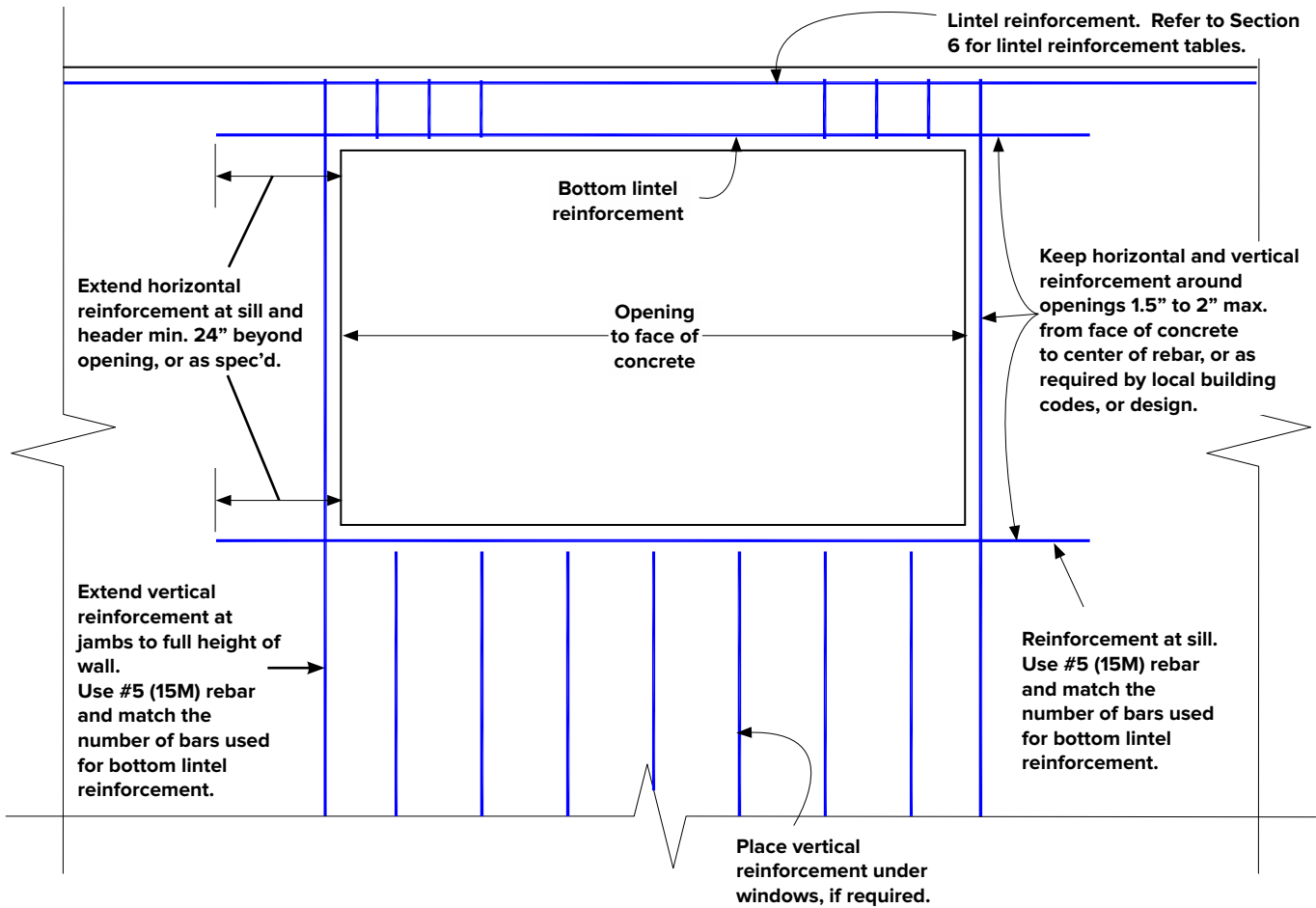

INSTALLATION GUIDE - REINFORCEMENT

**2.9.5 – LINTELS**

Appropriate lintel rebar should be placed in the proper sequence directly above doors and windows to carry loads over these openings.

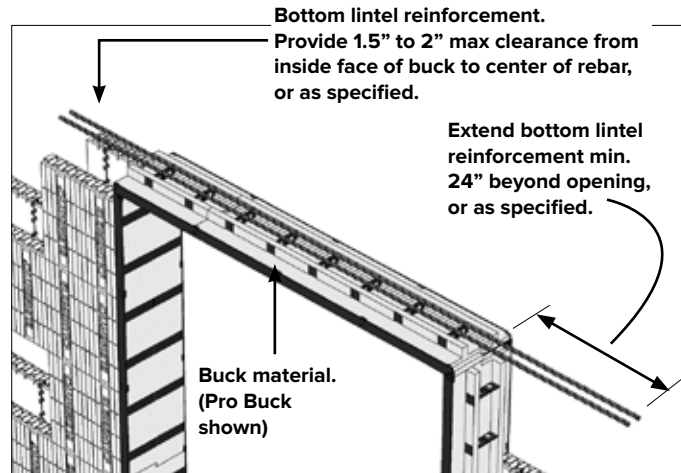

Before placing blocks across the top of door or window openings, rest the bottom lintel bar(s) on buck material.

NOTE: Block Lock can be installed across the entire length of the lintel span. In some cases it may be required to install top lintel rebar before installing Block Lock, in order to achieve necessary concrete cover.

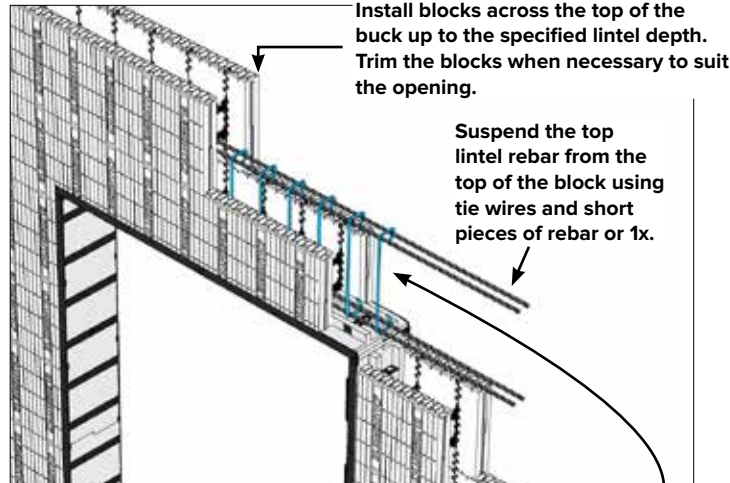

Use the stirrups to hang the bottom lintel rebar from the top steel. Depending on lintel depth and stirrup shape, it may be easier to rest the stirrups in place with the bottom lintel rebar before placing blocks above the top buck.

Refer to Element Prescriptive Engineering manual for lintel reinforcement tables, and lintel details.





## 2.10 – WINDOW & DOOR BUCKS

Bucks provide attachment surfaces for windows and doors while holding back concrete from these openings during concrete placement. Mark the center and edges of openings as you place courses and cut blocks as needed.

Refer to the rough opening (R/O) dimensions for windows and doors. Provide for openings in the wall taking into consideration the thickness of the chosen buck material. See window and door manufacturer info for R/O dimensions.

Cross bracing is required for all window and door bucks approximately 18 inches (457 mm) on center to help withstand the pressures of concrete placement.

Window and door openings within 4 feet (1.220 m) of corners require additional horizontal strapping from corner to across the opening.

Prior to placing window or door buck, confirm that bottom lintel rebar has been installed.

Bucks can be made from EPS foam, lumber or vinyl. Pro Buck, made of dense EPS foam, is recommended for use with Element ICF.

**2.10.1 – PRO BUCK™**

Recommended for use with Element ICF is the Pro Buck™ system. Designed for Element, Pro Buck creates a complete thermal break in window and door openings. And unlike wood and vinyl bucks, Pro Buck is light weight, faster and easier to install, while creating little job site waste. For more information refer to the Pro Buck Installation Guide.

For efficiency, a table long enough to accommodate connecting and cutting Pro Buck sections together is recommended. This can be done by simply using a pair of sawhorses and a section of plywood, or 2x lumber, such as 2x10 or 2x12 pieces.

Furring strips are molded with Tie-back Loops.

Anchors Pro Buck to concrete providing direct load path for fasteners to concrete.

Acts as rebar chair providing 1.5" concrete cover around openings.

Secures to Element ICF Flexties using zip-ties for additional support.

Exposed furring strips at 8" on center across width of Pro Buck for fastening window or door framing, and along the Pro Buck fins for picture framing.

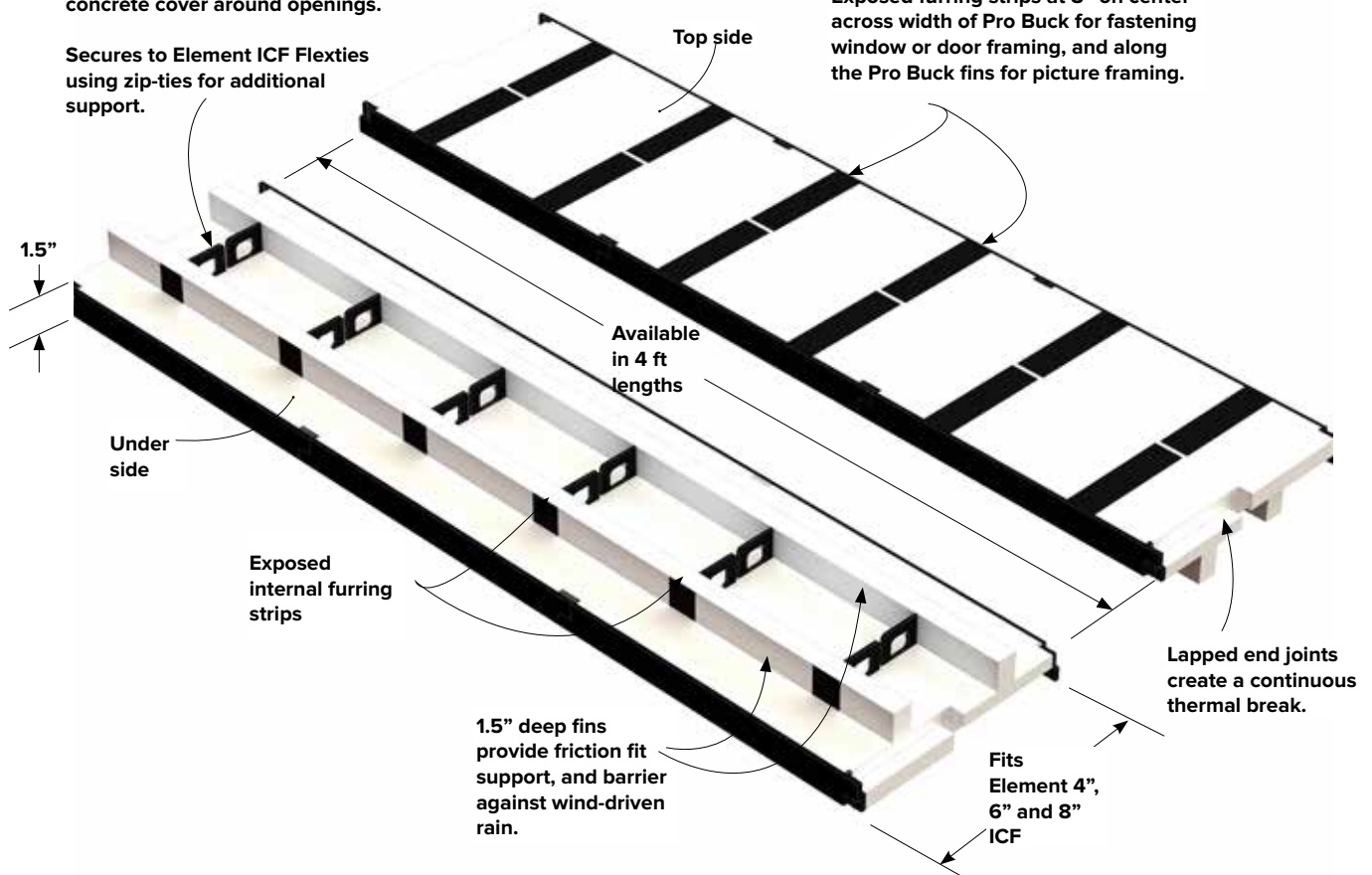

INSTALLATION GUIDE - WINDOW & DOOR BUCKS

When the walls are built to the height of the opening installation of the Pro Buck can begin. The rough opening is measured between the Pro Bucks. Therefore, to account for the 1.5" thickness of Pro Buck, the opening in the Element ICF wall should be cut 3" wider and 3" taller than the rough opening.

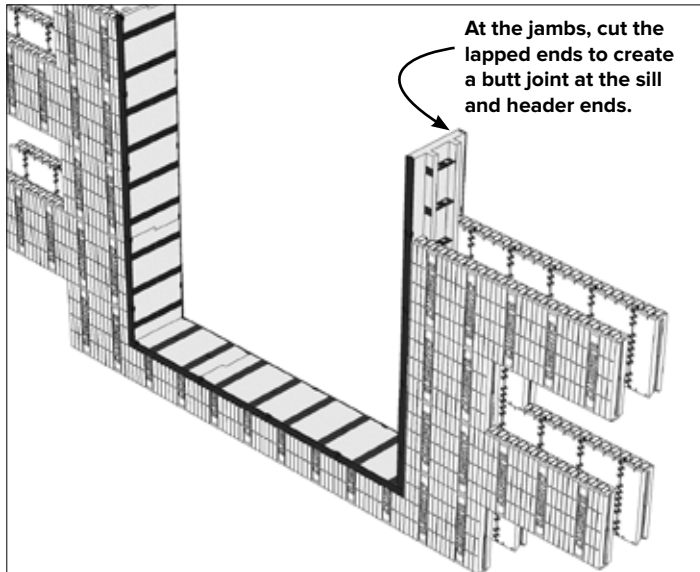

**STEP 1:** Assemble Pro Buck for the jambs, and cut the lapped ends to fit the height of the opening minus 1.5", which is the thickness of the Pro Buck at the header.

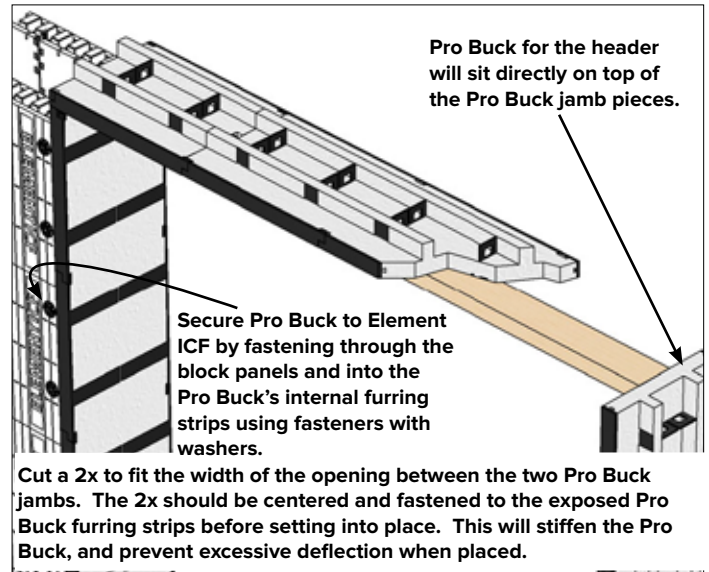

**STEP 2:** Install Pro Buck at the header. Cut the lapped ends to fit the entire width of the opening. The ends of Pro Buck will sit directly on the Pro Buck jamb pieces.

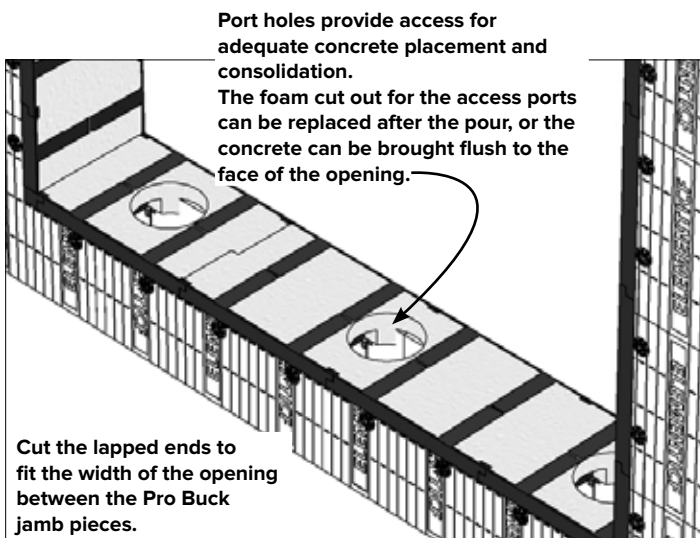

**STEP 3:** Install Pro Buck at the sill. To avoid debris in the wall cavity, cut min. 4" port holes at 16" on center before placing in the opening.

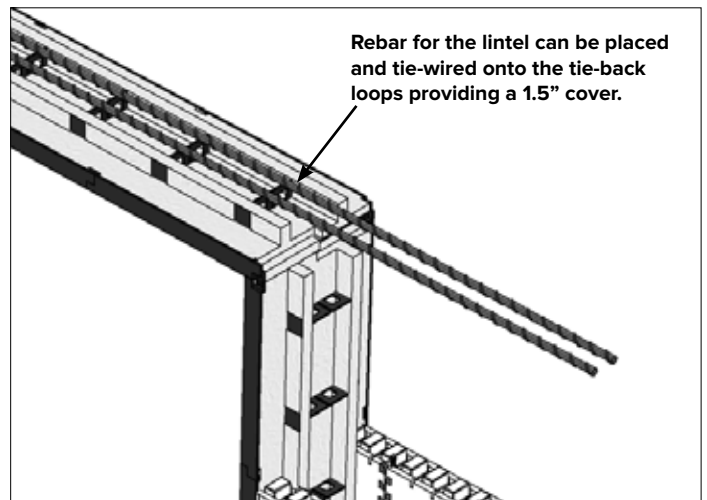

**STEP 4:** Continue installing blocks above the opening. Use zip ties around the tie-back loop to secure the Element blocks to the Pro Buck at the header.

Once the Pro Buck pieces are placed in the opening add 2x wood bracing, and Pro Buck Brackets, to secure the Pro Bucks during concrete placement. Wood screws are recommended when fastening wood bracing to Element Pro Buck.

NOTE: Using a membrane flashing is recommended to cover the joints between Pro Bucks and the Element blocks.

Provide picture framing every 8" at the sides to secure Pro Bucks if there are more than 3 foam bars unsupported by a web along the sides of the opening. Fasten to internal furring strips<sup>1</sup> with Wind Devils or equivalent<sup>2</sup>

Cut vert. 2x wood sections to fit snug between top horiz. 2 x wood piece and bottom 2 x wood sections. Toe-nail into place.

Cut horiz. 2x wood sections to fit snug between 2 x wood jamb pieces, and toe-nail into place. Fasten vertical bracing to horizontal bracing. Provide every 2 ft.

Cut 2x wood sections at jambs to fit snug between top horiz. 2 x wood piece and bottom 2 x wood sections. Center and toe-nail into place and fasten to furring strips.

Cut 2x wood sections to support vertical bracing every 2 ft. Add additional wood sections at corners. Fasten to furring strips.

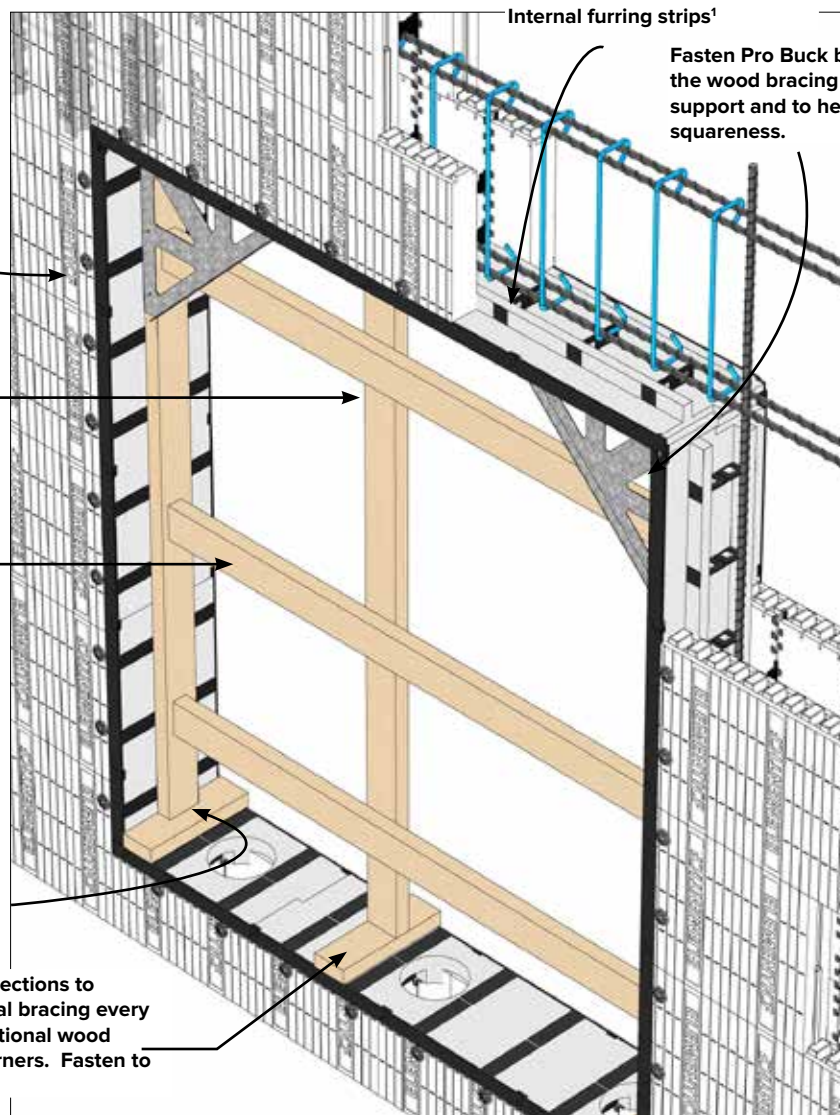

1. Internal furring strips are easy to locate as they are in the same spot as the exposed furring strips that run across the face of Pro Buck.
2. Wind Devil fasteners are available from [www.wind-lock.com](http://www.wind-lock.com). Finishes such as stucco, or acrylic textured finishes can be applied directly over Wind Devil fasteners.

Non-corrosive wood screws are recommended for the attachment of window or door frames. Inset or flanged windows and doors are fastened to the furring strips molded into the Pro Buck. The furring strips are anchored into the concrete providing proper load transfer from the window/door to the concrete substrate.

To determine the fastener type and spacing for load rated windows and doors, withdrawal and lateral load resistance of specific fasteners are provided below.

**Direct Fastening to Furring Strips**

	Allowable Withdrawal <sup>1</sup>	Allowable Lateral <sup>1</sup>
#6 wood screw, min 1" long	30 lb	72 lb
#8 wood screw, min 1.25" long	38 lb	188 lb
#10 wood screw, min 1" long	34 lb	90 lb

1. Withdrawal factor of safety = 5, allowable lateral load based on the lesser of factor of safety of 3.2 or 75% of proportional limit. Based on independent fastener testing conducted by QAI Laboratories, in accordance with ASTM D1761, and ASTM E2634.

Where heavier load conditions are expected, mullion anchorage or where fixtures may not align with furring strips for proper fastening, such as door hinges, the Element Wall Plates are recommended. The Wall Plates provide additional fastening edges between Pro Buck furring strips, and provide stronger fastener resistance. Withdrawal and lateral load resistance of specific fasteners are provided below.

**Direct Fastening of Wall Plate Inserts**

	Allowable Withdrawal <sup>1</sup>	Allowable Lateral <sup>1</sup>
#8-18x1" long self-tapping screw	102 lb	142 lb
#10-16x1.5" long self-tapping screw	106 lb	171 lb

1. Withdrawal factor of safety = 5, lateral resistance factor = 0.5 & 0.53 for #8 and #10 screws, respectively. Based on independent fastener testing conducted by QAI Laboratories, in accordance with ASTM D1761, and ASTM E2634.

To insert Wall Plate cut a narrow slit on the face of Pro Buck.

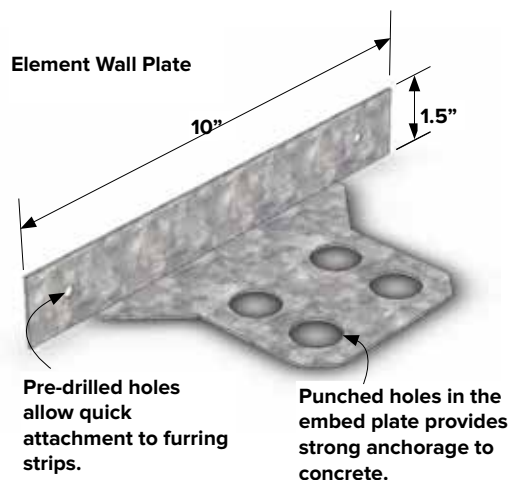

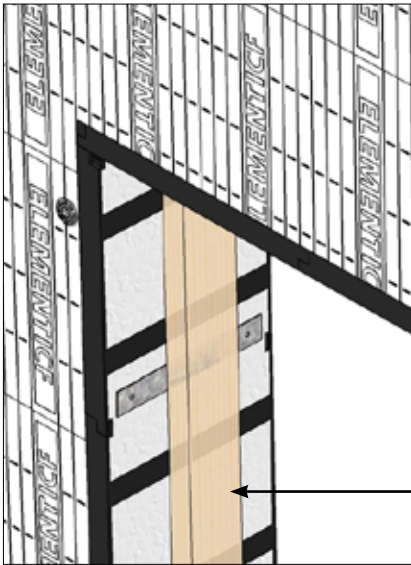

Wall Plate at front face of Pro Buck

Bracing support for opening can support the Wall Plate during concrete placement.

The Wall Plate securely anchors into the concrete core. When placed transversely to the opening holes punched in the Wall Plate allow for the placement of perimeter reinforcement.

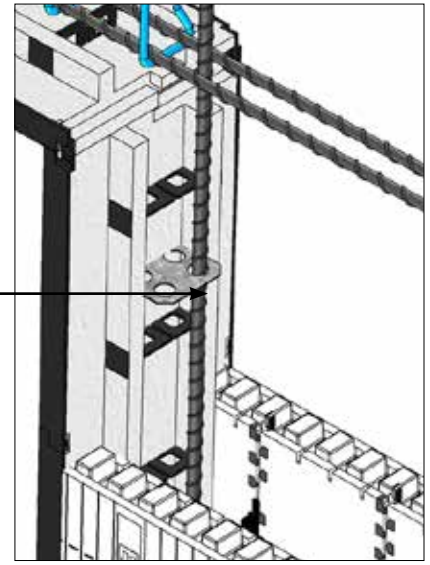

Wall Plate at back side of Pro Buck

Pro Buck can also be installed length wise along the opening and temporarily fastened to the furring strips at pre-drilled holes, if required.



## 2.10.2 – TREATED PLYWOOD BUCK

Following are several methods for building bucks. Regardless of the method chosen, pre-planning is required to optimize chosen finish materials.

**STEP 1:** Rip 3/4 inch (19 mm) treated plywood to full block width.

**STEP 2:** Rip treated 2x4 diagonally on table saw at 180° angle.

**STEP 3:** Assemble buck with appropriate fasteners with 2x4s creating a dovetail detail.

**STEP 4:** Assemble buck sides and top with access holes cut in bottom piece for placement of concrete. Two 2x4s can also be used for the bottom to allow concrete placements.

**STEP 5:** Place pre-assembled buck in opening and fasten in place with foam adhesive. The buck can also be installed in opening as separate pieces.

**STEP 6:** Install temporary cross bracing to withstand concrete pressure. Attaching screws through the buck and into closest webs can provide additional buck support.

**NOTE:** Pressure treated wood for window bucks are normally required only if the bottom of the window buck frame is located at or below ground level. Check with local building codes to determine if your area requires pressure treated window bucks.

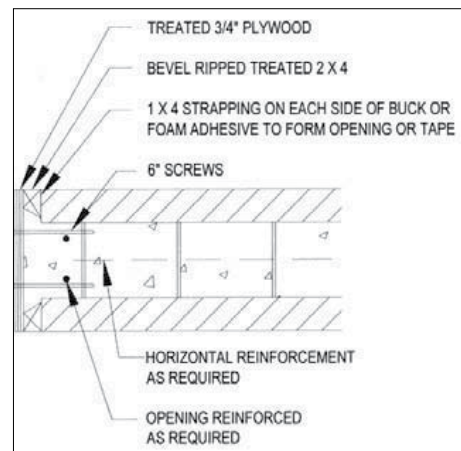

### 2.10.3 – SOLID WOOD BUCK

STEP 1: Choose appropriate wood product based on the dimension of the blocks:

- 4" (102mm) block: 9.5" (241mm)
- 6.25" (159mm) block: 11.75" (298mm)
- 8" (203mm) block: 13.5" (343mm)
- 10" (254mm) block: 15.5" (394mm)

STEP 2: Cut top piece of buck to fit the width of the opening.

STEP 3: Cut sides of buck, remembering that the top piece rests on the side pieces.

STEP 4: Cut two 2x4s for the bottom to allow concrete placement.

STEP 5: Assemble buck and place in opening.

STEP 6: Once the buck is in place, it must be centered and secured. This can be done by attaching 1x4s to the edges of the buck, extending the edge of the 1x4 over the foam to hold the buck firmly in place. Alternately, the buck can be secured with foam adhesive and tape.

STEP 7: Solid wood bucks will require additional concrete anchors to create a permanent attachment to the concrete.

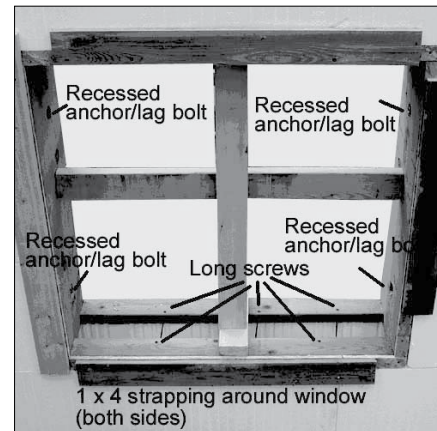





## 2.10.4 – RADIUS OPENINGS

Radius windows and doors can be assembled at the site with shortened pieces of Pro Buck or lumber buck material.

**STEP 1:** Create the template for the radius opening with OSB or plywood that matches door or window rough opening.

**STEP 2:** Using template, draw outline of radius on wall, allowing for buck material thickness. Cut accordingly.

**STEP 3:** Cut buck material into approximately 4 inch (102 mm) widths to create radius buck.

**STEP 4:** Cut side and bottom buck pieces. Leave openings in the bottom piece for concrete placement and consolidation.

**STEP 5:** Assemble buck pieces in the opening in the following order:

- bottom
- sides
- radius top

**STEP 6:** Once the buck is in place, it must be centered and secured. This can be done by attaching 1x4s to the edges of the buck, extending the edge of the 1x4 over the foam to hold the buck firmly in place. Alternately, the buck can be secured with foam adhesive and tape. Insert the radius template in opening to provide additional support.

**STEP 7:** Solid wood bucks will require additional concrete anchors to create a permanent attachment to the concrete.

**2.10.5 – METAL JAMBS**

Metal jambs are typically used in commercial applications. Many metal jamb companies will pre-bend jambs to fit Element blocks. Contact your local Element representative for more details.

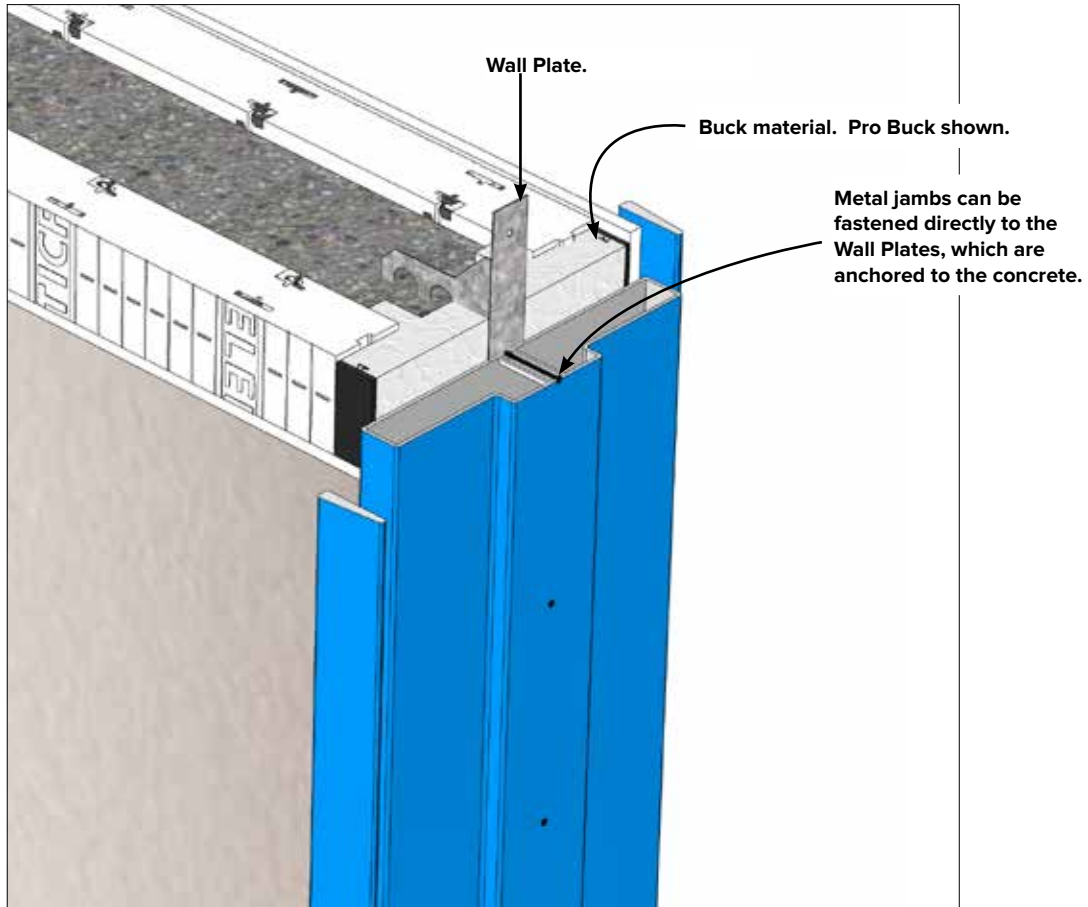

INSTALLATION GUIDE - WINDOW & DOOR BUCKS



## 2.11 – ADDITIONAL BLOCK SUPPORT

For added strength, bridging flexties can be used to permanently lock blocks together, top to bottom, potentially lessening the need for additional form support or bracing in your wall.

### 2.11.1 – STRAPPING AND BRACING

Vertical joint between Element blocks (shown as a dark line)

More than 3 bars from web (shown shaded).

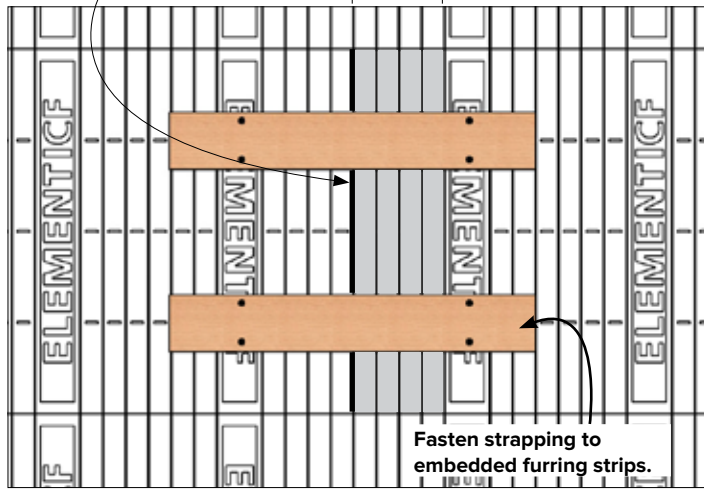

Provide wood strapping on both sides of Element when there are more than 3 bars beyond a web.

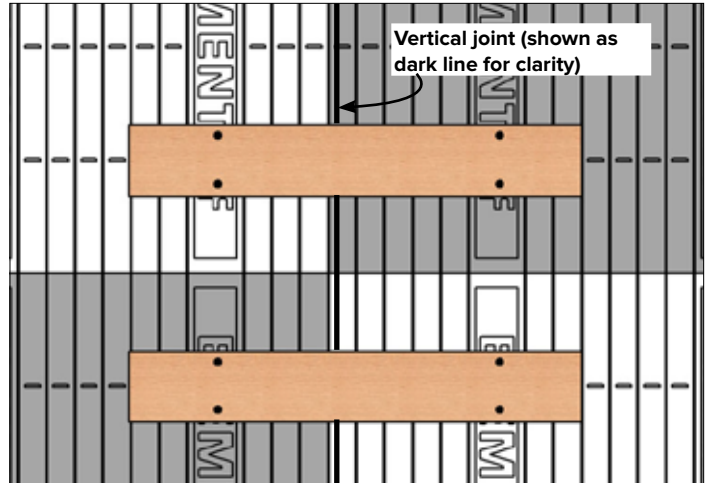

Provide wood strapping on both sides of Element when vertical joints are directly on top of each other, or offset between joints is less than 8" between courses.

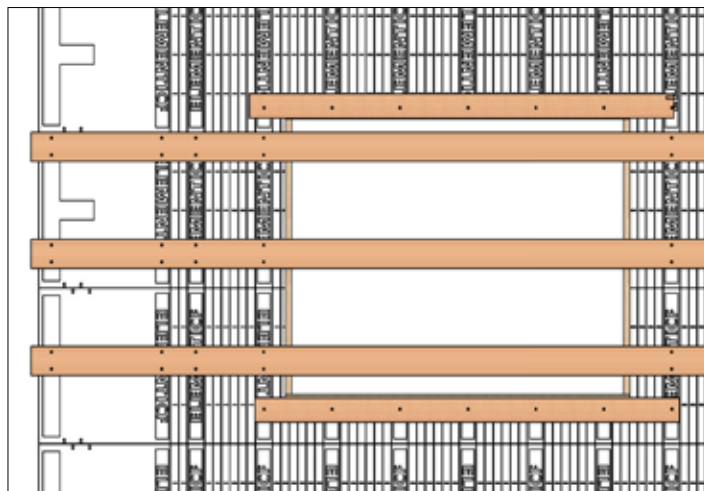

Provide wood strapping on both sides of Element at window and door openings less than 4 feet from a corner. Run strapping across opening. Fasten to embedded furring strips, and bracing around openings.

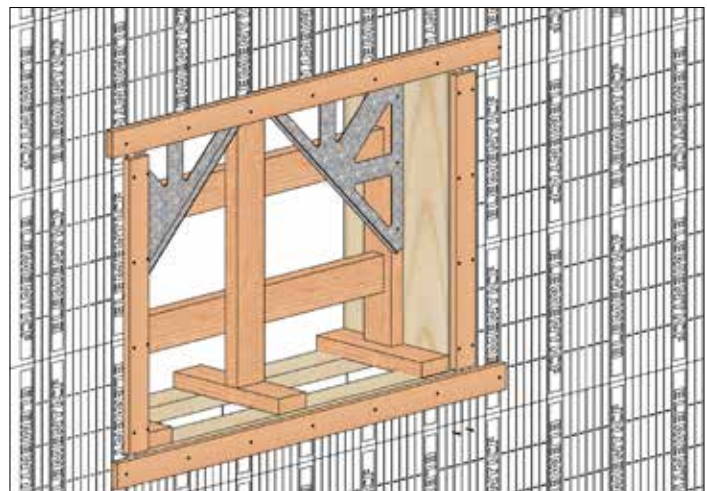

Wood strapping is required around window and door openings to maintain straightness. In addition, cross bracing with 2x4 supports is required inside window and door bucks to hold bucks in place and prevent sagging. Use foam adhesive on bucks to provide additional buck support.

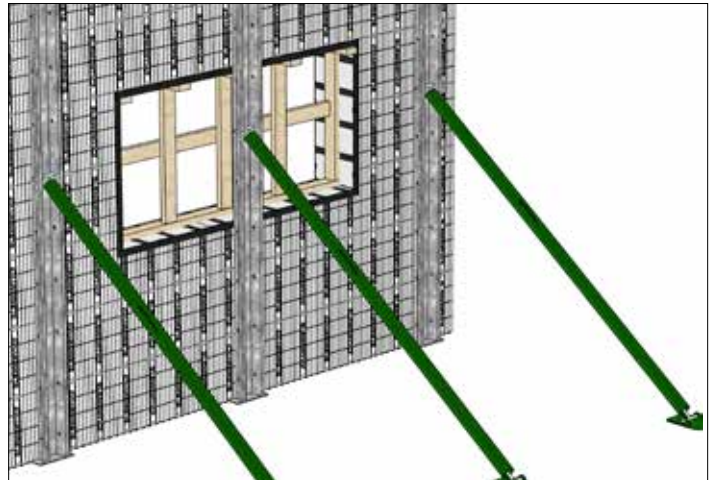
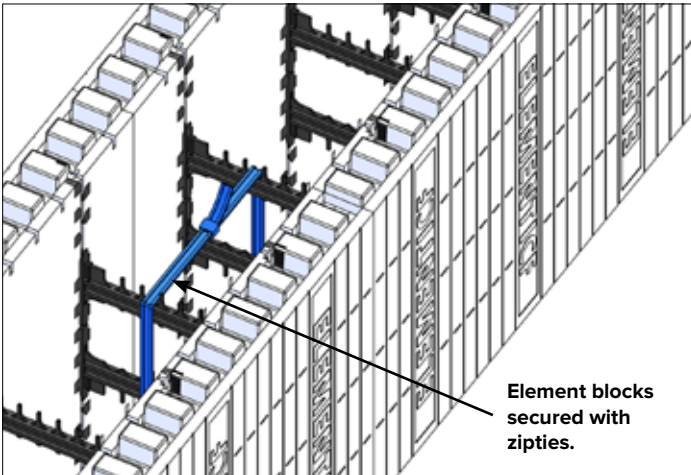

The top course and lintels should be secured with adhesive foam, zip ties, or Horizontal Hooks.

The middle of large openings should be vertically braced to prevent tipping.

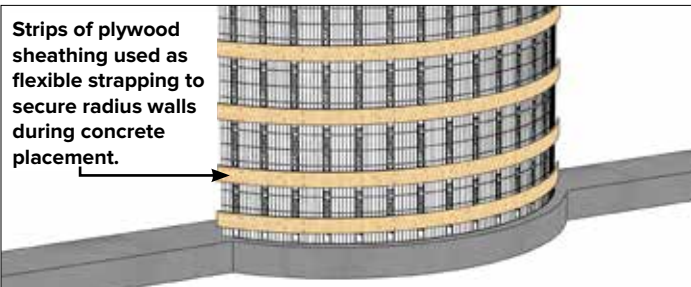

Radius walls should be secured with foam adhesive and flexible strapping material.

**NOTE:** All blocks should be firmly seated to prevent settling.

**2.11.2 – CORNER BLOCK SUPPORT**

For any type of ICF system it is good practice to provide additional block support at the corners. To ensure a safe and proper concrete pour the following corner block support is recommended:

- Using 2.5 inch (64 mm) wood screws to fasten 2x6 vertically to the embedded furring strips on both sides of the corner .
- For inside corners apply typical bracing as required.

Alternatively, bridging flexties can be used to reduce the amount of block support required. See “2.11.3 – Bridging Flexties” on page 55

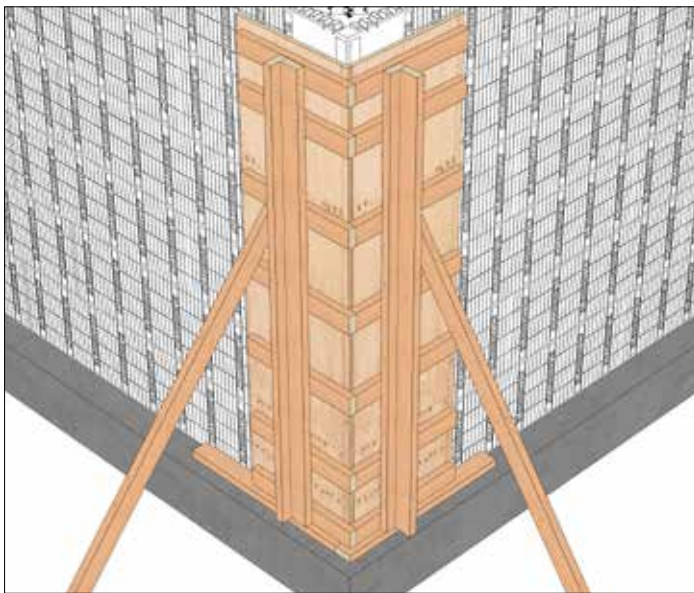

Example of outside corner block support.

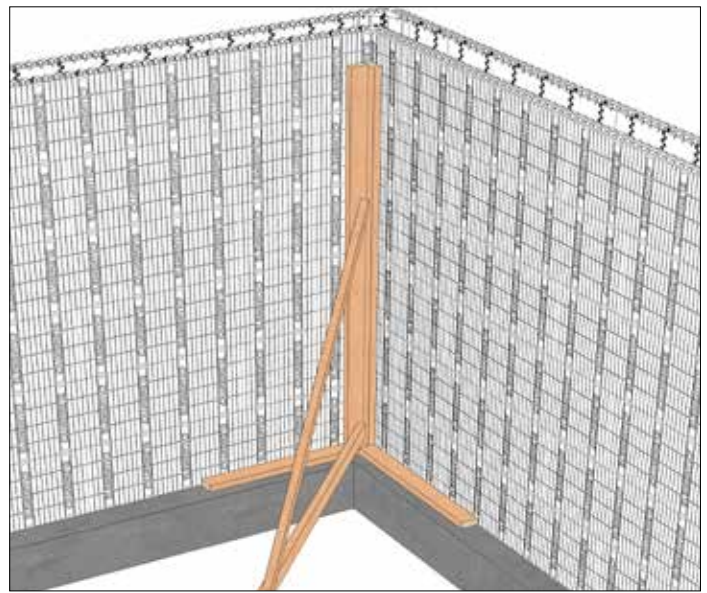

Example of inside corner block support.

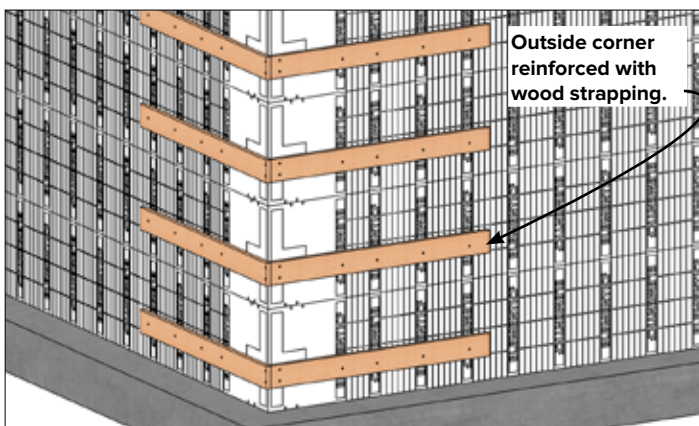

All outside corners can be reinforced with tape, or wood strapping, and zip ties.

**NOTE:** To ensure proper alignment bracing is recommended at the corner locations. See “2.12 – WALL BRACING & ALIGNMENT SYSTEM” on page 56

If you need to stack identical corners in subsequent courses, you will need to provide additional block support where the stacked joints are created.

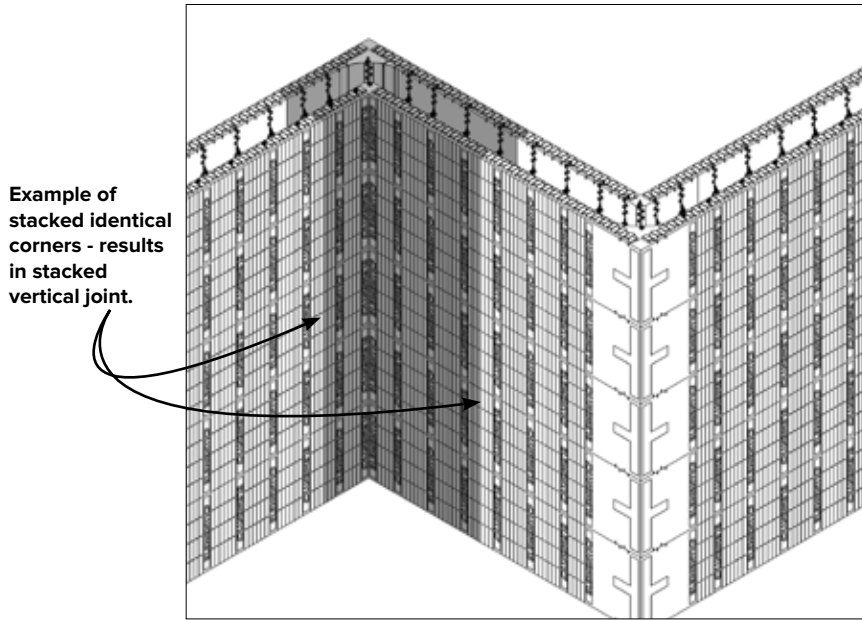

Example of stacked identical corners - results in stacked vertical joint.

Vertical stacked joints requires additional block support.

**2.11.3 – BRIDGING FLEXTIES**

Utilizing flexties across the joints between courses in site-assembled blocks increases the concrete block pressure resistance for the Element ICF wall system. This is referred to as “Bridging Flexties.” Consider Bridging Flexties where higher than normal block pressure is anticipated including in corner blocks.

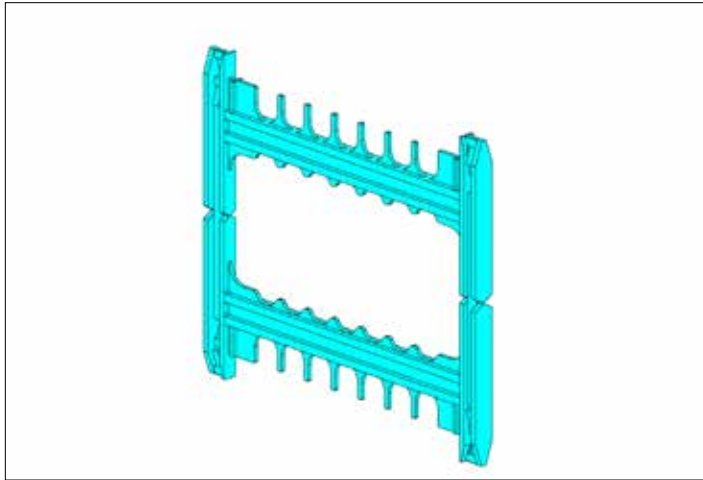

Additional Flexties can be used to increase block pressure resistance (shown in blue for clarity).

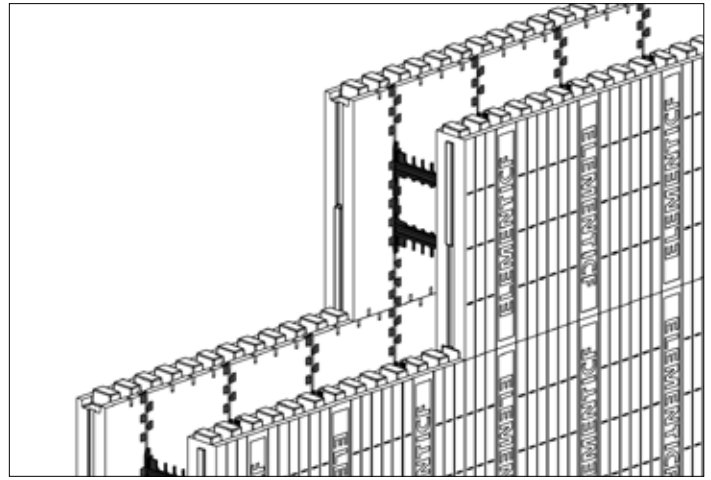

Conventionally placed Element blocks without Bridging Flexties.

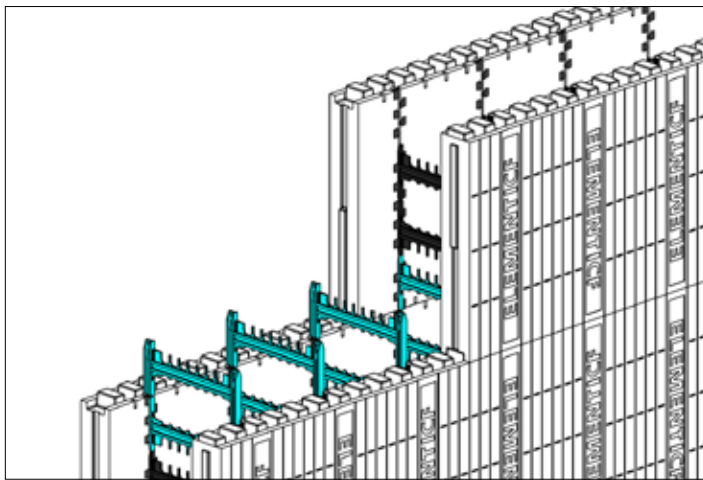

Bridging Flexties added for additional block support.

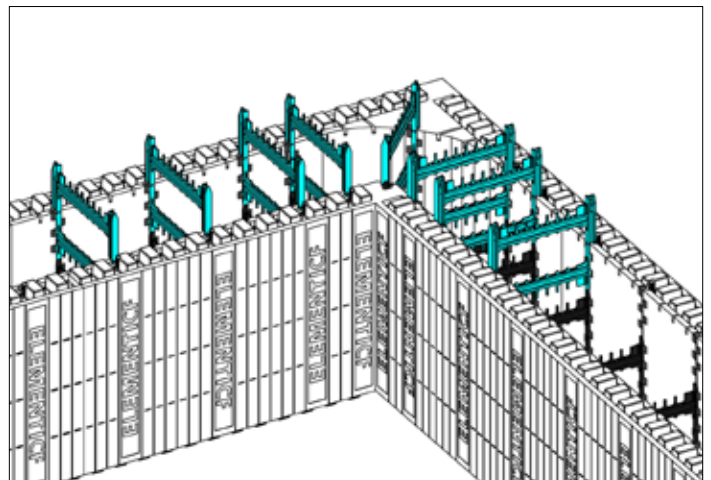

Bridging Flexties at corners.

## 2.12 – WALL BRACING & ALIGNMENT SYSTEM

A bracing system provides support for the wall and acts an alignment system to keep the walls straight and plumb during concrete placement. Typically, the wall alignment system is installed on the inner side of the Element wall, and installed after placing 2 to 4 courses of Element blocks (depending on wind and other conditions).

**STEP 4:** Place appropriate scaffolding planks and rails according to safety regulations. For requirements on toe board and handrail configuration, consult OSHA/OHSA.

**STEP 3:** Insert scaffold bracket behind the top of the turnbuckle and secured at the bottom with an additional bolt.

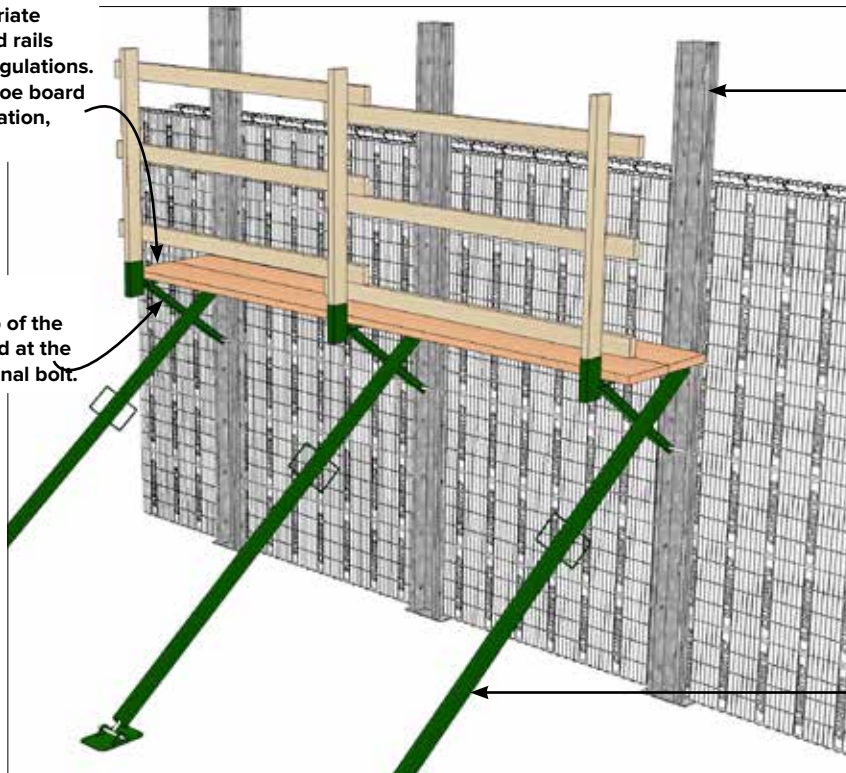

**STEP 1:** Upright steel channel with slots for screw attachments. Attach to the Element furring strips with a hex head #10 screw in each course. The screws should be snug but not tight. Always place screws near the top of the slots to accommodate settling at the interlock during concrete placement.

**STEP 2:** Attach turnbuckle arm to the upright with a bolt and then secure to the floor or ground. In light or sandy soil, additional care must be taken to secure diagonal turnbuckle.

Recommended minimum spacing and bracing locations:

- no more than 2 feet (0.610 m) from each corner or wall end, and every 7 feet (2.134 m) or less thereafter, in accordance with OSHA/OHSA requirements.
- on either side of every door and window opening.
- along door and window openings that span more than 6 feet (1.829 m)

**NOTES:** Prior to concrete placement, make certain walls are aligned perfectly plumb, or leaning slightly inward. The wall must not lean out at all.

A string line must be used to achieve straight walls. See Section “2.8.3 – ADDITIONAL COURSES” on page 20.

Before, during and after concrete placement, the diagonal turnbuckle arm is used to adjust wall straightness to stringline.

Proprietary bracing systems are available through ICF dealers or bracing suppliers.

For tall wall bracing and alignment see Section 3.2, Tall Wall Bracing Systems.



## 2.13 – FLOOR CONNECTIONS

Any type of floor system can be easily integrated with Element. For any questions or assistance, please contact your local Element representative.

### 2.13.1 - LEDGER WITH ANCHOR BOLTS & JOIST HANGERS

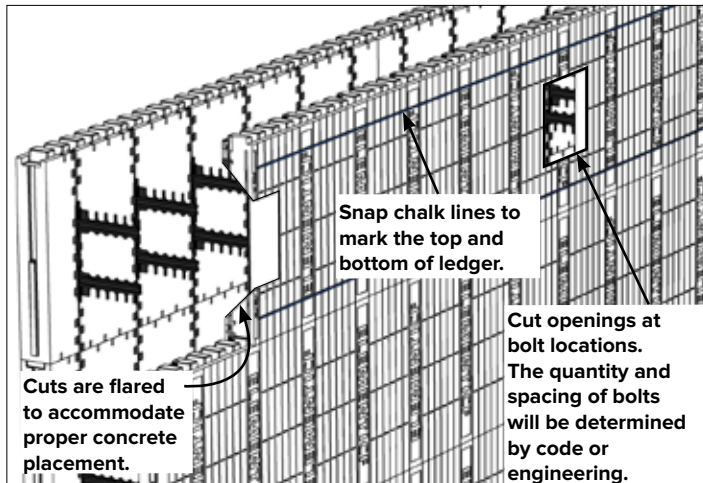

STEP 1: Snap chalk lines and cut openings for bolt locations.

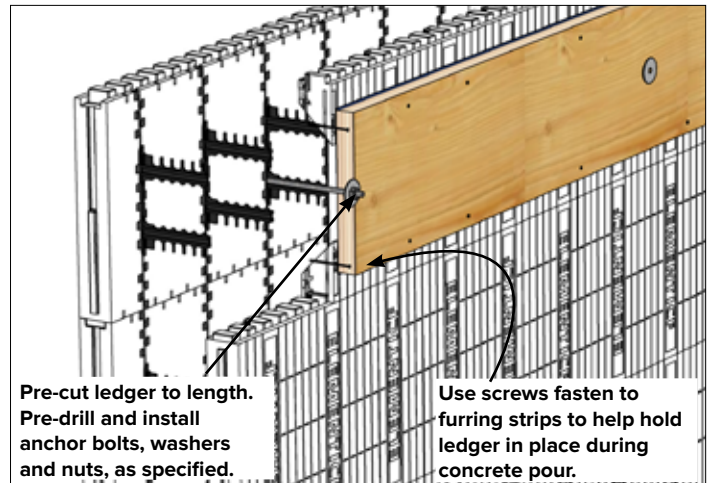

STEP 2: Install ledger with anchor bolts.

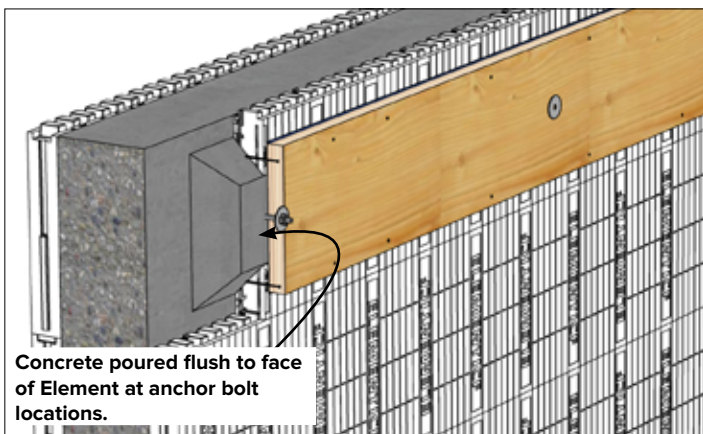

STEP 3: Place concrete.

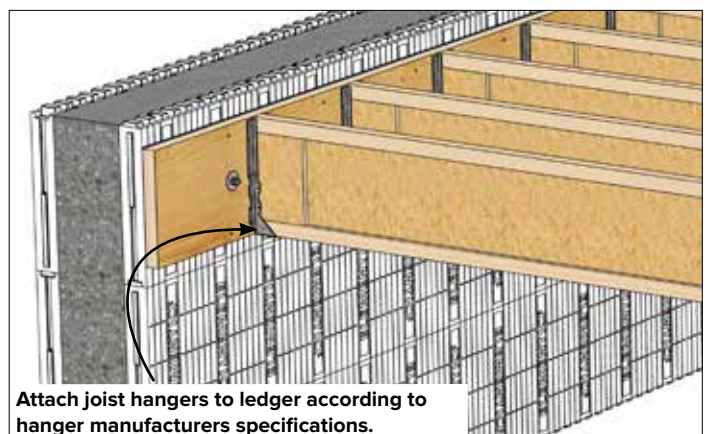

STEP 4: Install joist hangers.

**2.13.2 – STEEL ANGLE IRON LEDGER**

When floor spans become very long or concrete topping is applied to the floor, a wood ledger may not be adequate to support floor loads. In this case a steel angle iron can be used in place of a wood ledger. The angle iron can support much more weight and also eliminates the need for joist hangers, as the floor system sits right on the angle.

To install an angle iron ledger follow the steps in Section “2.13.1 - LEDGER WITH ANCHOR BOLTS & JOIST HANGERS” on page 57, but use pieces of plywood to temporarily hold the bolts in place. After the pour drill and bolt on the angle iron. Local steel fabricators may be able to pre-drill your angle iron.

Another alternative is to pre-fabricate an angle iron with anchor bolts or nelson studs welded directly to the angle. The entire assembly is then cast in place. This application is described below.

INSTALLATION GUIDE - FLOOR CONNECTIONS

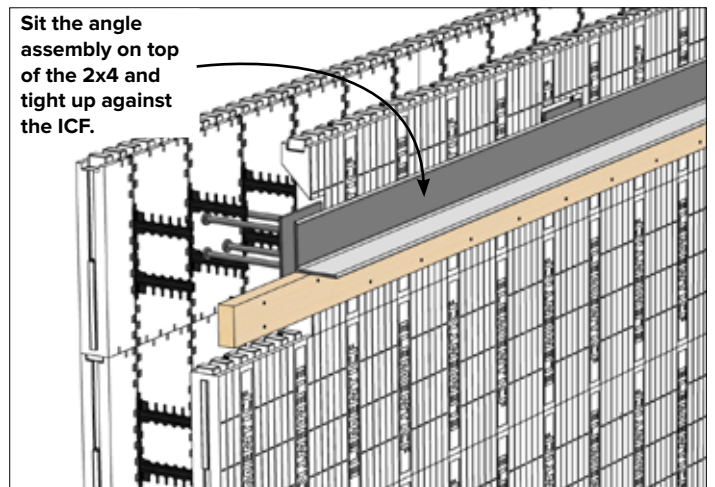
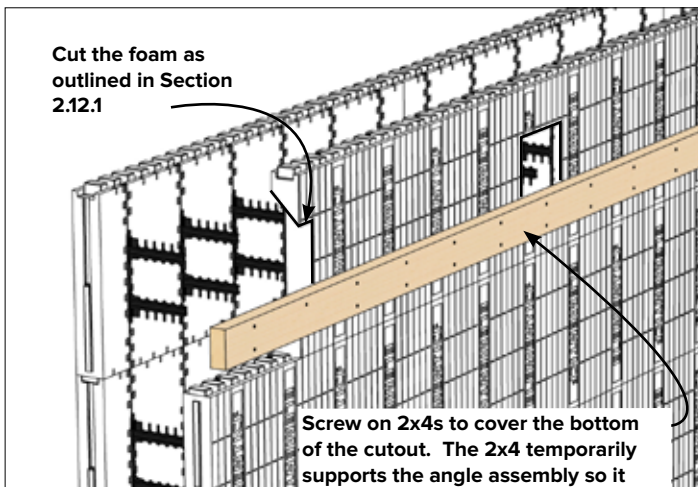

**STEP 1:** Cut foam to accommodate anchors, and install 2x4 to support angle assembly.

**STEP 2:** Install 2x4 to support angle assembly.

The 2x4s can be screwed to the embedded furring strips.

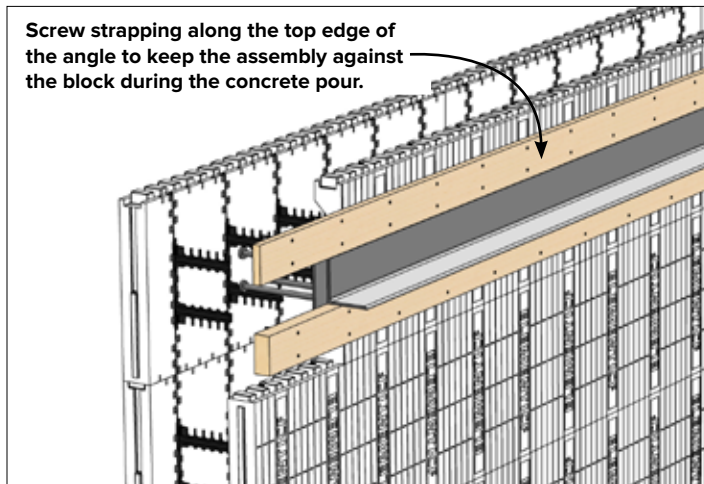

STEP 3: Install strapping to support angle assembly.

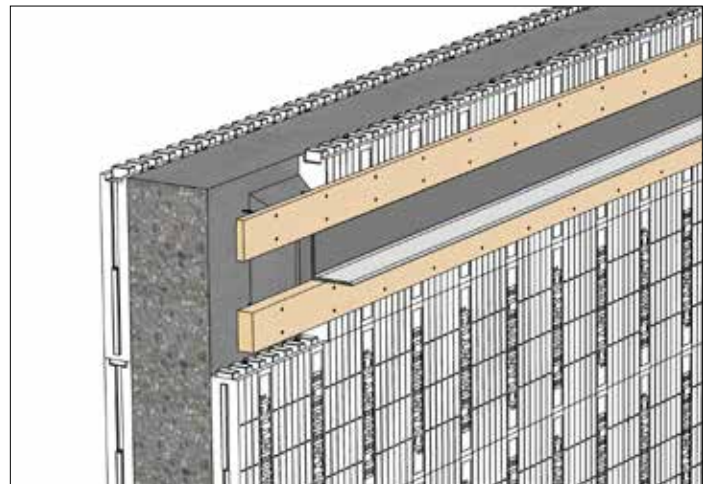

STEP 4: Pour concrete and cast the assembly in place.

NOTE: It is code in some areas for the angle assembly to be primed.

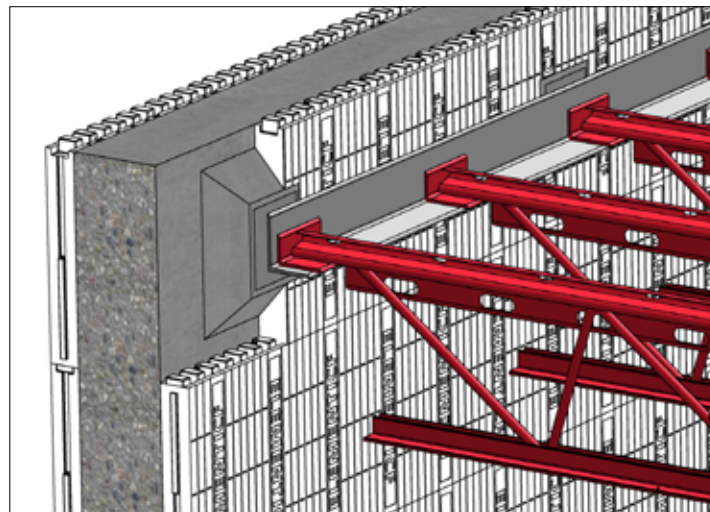

STEP 5: After some curing place floor systems on the angle and establish layout. Once layout is complete fasten the floor joist to the angle iron, as specified. You may decide to attach a nailing surface to the bottom leg of the angle iron to nail joists to.

**2.13.3 – BRICK LEDGE FOR TOP & BOTTOM CHORD BEARING SYSTEMS**

The Element Brick Ledge block can create a load bearing surface to support floor systems, including top and bottom chord bearing trusses or joists.



Top chord bearing on Element Brick Ledge.



Top chord bearing on Element Brick Ledge.

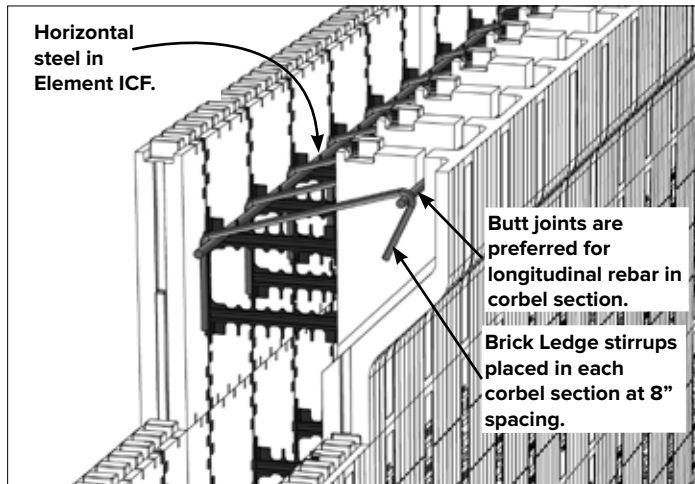

STEP 1: Install a course of Element Brick Ledge, and place required reinforcement.

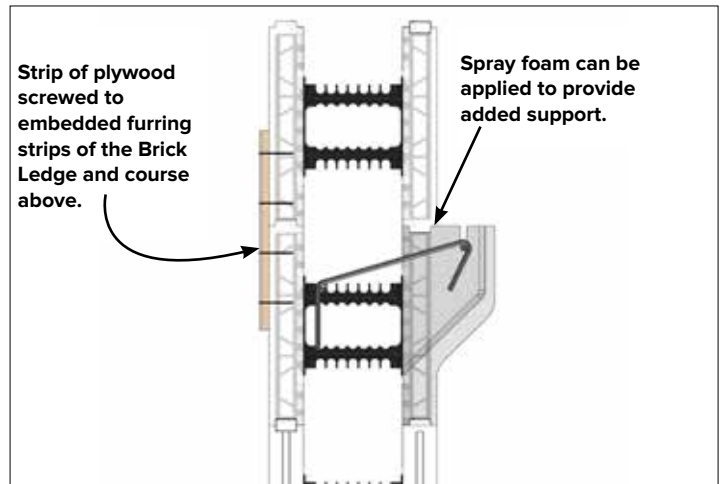

STEP 2: When installing a course above the Element Brick Ledge add additional block support to prevent tilting or separating.

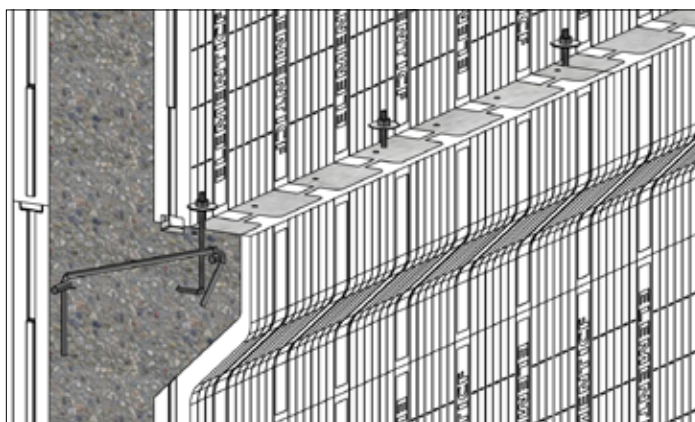

STEP 3: As concrete is placed, install embedments, as required.

NOTE: If the Element block in the course above the Brick Ledge is of a smaller width than the Brick Ledge, additional block support will be required.

INSTALLATION GUIDE - FLOOR CONNECTIONS



**2.13.4 – LEDGER WITH SIMPSON BRACKET & JOIST HANGERS**

The ICFVL & ICFVL-W ledger connector system from Simpson Strong-Tie is designed for mounting steel or wood ledgers on ICF walls.

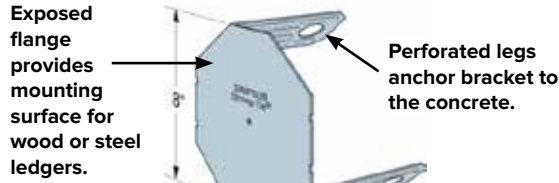

ICFVL bracket is inserted through the Element block panels prior to concrete placement.

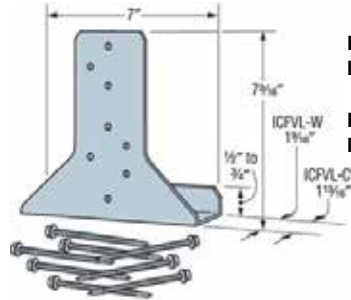

ICFVL-W is used with 1 1/2" wood ledgers.

ICFVL-CW is used with 1 3/4" LVL ledgers.

ICFVL-W and ICFVL-CW brackets are installed on the ledger and screwed to the embedded ICFVL.

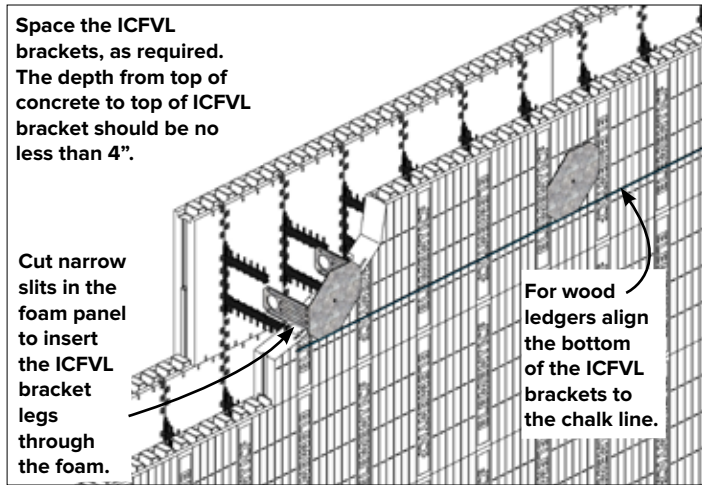

Space the ICFVL brackets, as required. The depth from top of concrete to top of ICFVL bracket should be no less than 4".

Cut narrow slits in the foam panel to insert the ICFVL bracket legs through the foam.

For wood ledgers align the bottom of the ICFVL brackets to the chalk line.

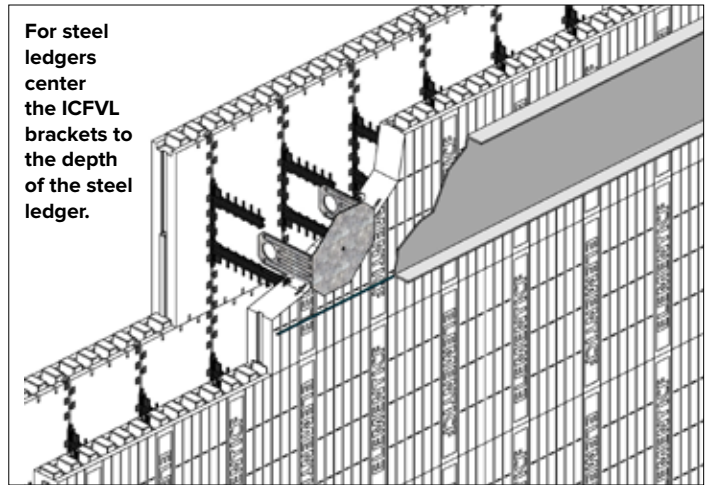

For steel ledgers center the ICFVL brackets to the depth of the steel ledger.

STEP 1: Snap a chalk line to mark the bottom of the ledger and insert ICFVL brackets, as specified.

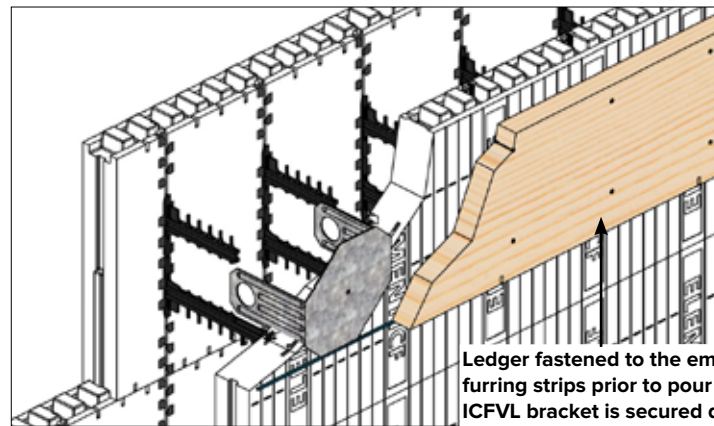

Ledger fastened to the embedded furring strips prior to pour ensures ICFVL bracket is secured during concrete placement.

STEP 2: Secure the ICFVL brackets before placing concrete. Fastening strapping across the brackets or installing the ledgers prior to concrete placement will help ensure full concrete embedment of the ICFVL brackets.

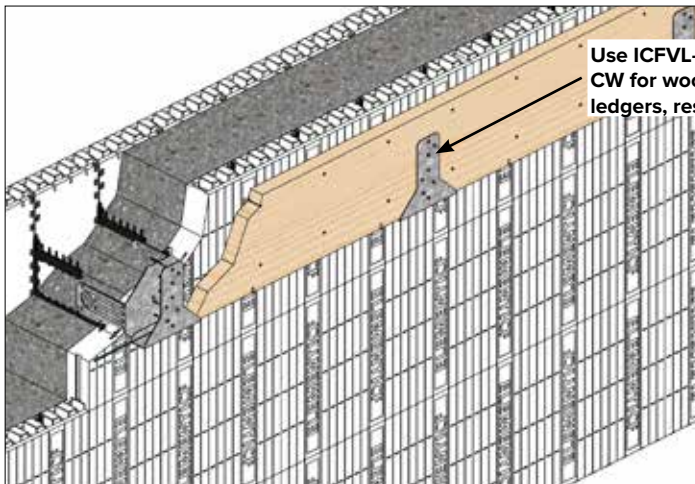

Use ICFVL-W or ICFVL-CW for wood and LVL ledgers, respectively.

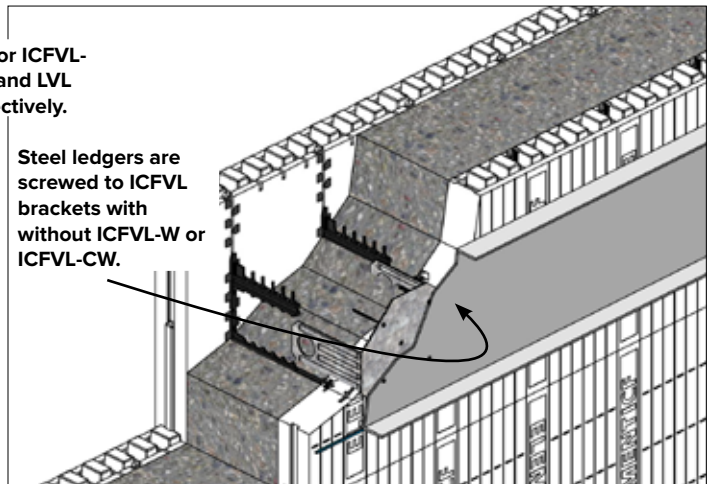

Steel ledgers are screwed to ICFVL brackets with or without ICFVL-W or ICFVL-CW.

**STEP 3:** Place and consolidate concrete. Once set, slip the ICFVL-W or ICFVL-CW underneath the wood ledger and drive eight ICF-D3.25 screws through the ledger and into the ICFVL bracket. ICF-D3.25 screws are supplied by Simpson Strong-Tie.

For steel ledgers use four #14 x 3/4" screws to attach the ledger to the ICFVL brackets. These screws are not supplied by Simpson Strong-Tie.



**STEP 4:** Connect the floor joists to the ledgers, as required.

**NOTE:** Industry studies show that hardened fasteners can experience performance problems in wet environments. Accordingly, use this product in dry environments only. In addition, due to its corrosive nature, treated lumber should not be used with this product.

Use extra caution when installing the hangers on both sides of a wall. Consult your local Simpson Strongtie rep or contact Simpson Strongtie at (800) 999-5099 prior to installation.

Complete technical data is available at [www.strongtie.com](http://www.strongtie.com)



**Simpson Strong-Tie Ledger Connector Loads & Spacings**

Ledger Type	Model No.	6" x 8" & 10" LOGIX ICF				4" LOGIX ICF				Spacing to Replace Anchor Bolts <sup>3,4,6</sup>							
		Allowable Vertical Resistance <sup>2</sup>		Factored Vertical Resistance		Allowable Vertical Resistance <sup>2</sup>		Factored Vertical Resistance		1/2" Dia. Bolts at		5/8" Dia. Bolts at					
		lbs	(kN)	lbs	(kN)	lbs	(kN)	lbs	(kN)	12"	24"	36"	48"	12"	24"	36"	48"
2xD.Fir-L/SPF w/ICFVL-W	ICFVL w/ICFVL-W	1375	1894	1890	2630	4i	4i	4i	4i	12"	24"	36"	48"	12"	24"	36"	48"
		(6.12)	(8.42)	(8.41)	(11.70)	(1220mm)	(1220mm)	(1220mm)	(1220mm)	(305mm)	(610mm)	(914mm)	(1220mm)	(305mm)	(610mm)	(914mm)	(1220mm)
1 3/4" LVL	ICFVL w/ICFVL-CW	1375	1894	1890	2630	4i	4i	4i	4i	12"	24"	36"	48"	3i-6i	4i	4i	4i
		(6.12)	(8.42)	(8.41)	(11.70)	(1220mm)	(1220mm)	(1220mm)	(1220mm)	(305mm)	(610mm)	(914mm)	(1220mm)	(1067mm)	(1220mm)	(1220mm)	(1220mm)
(0.054") 16ga	ICFVL	1770	1894	2435	2630	1i-3i	2i-3i	--	--	1i	2i	--	--	1i	2i	--	--
		(7.87)	(8.42)	(10.83)	(11.70)	(381mm)	(686mm)	--	--	(305mm)	(610mm)	--	--	(305mm)	(610mm)	--	--
(0.068") 14ga	ICFVL	1770	1894	2435	2630	1i	2i	--	--	1i	2i	--	--	9i	1i-6i	--	--
		(7.87)	(8.42)	(10.83)	(11.70)	(305mm)	(610mm)	--	--	(229mm)	(457mm)	--	--	(229mm)	(457mm)	--	--

Ledger Type	Model No.	6" x 8" & 10" LOGIX ICF				4" LOGIX ICF				Spacing to Replace Anchor Bolts <sup>3,4,6</sup>							
		Allowable Vertical Resistance <sup>2</sup>		Factored Vertical Resistance		Allowable Vertical Resistance <sup>2</sup>		Factored Vertical Resistance		2-5/8" Dia. Bolts at		3/4" Dia. Bolts at					
		lbs	(kN)	lbs	(kN)	lbs	(kN)	lbs	(kN)	12"	24"	36"	48"	12"	24"	36"	48"
2xD.Fir-L/SPF w/ICFVL-W	ICFVL w/ICFVL-W	1375	1894	1890	2630	1i-9i	3i-9i	4i	4i	12"	24"	36"	48"	12"	24"	36"	48"
		(6.12)	(8.42)	(8.41)	(11.70)	(533mm)	(1143mm)	(1220mm)	(1220mm)	(305mm)	(610mm)	(914mm)	(1220mm)	(305mm)	(610mm)	(914mm)	(1220mm)
1 3/4" LVL	ICFVL w/ICFVL-CW	1375	1894	1890	2630	1i-9i	3i-6i	4i	4i	12"	24"	36"	48"	3i-6i	4i	4i	4i
		(6.12)	(8.42)	(8.41)	(11.70)	(533mm)	(1067mm)	(1220mm)	(1220mm)	(305mm)	(610mm)	(914mm)	(1220mm)	(838mm)	(1220mm)	(1220mm)	(1220mm)
(0.054") 16ga	ICFVL	1770	1894	2435	2630	--	--	--	--	--	--	--	--	--	--	--	--
		(7.87)	(8.42)	(10.83)	(11.70)	--	--	--	--	--	--	--	--	--	--	--	--
(0.068") 14ga	ICFVL	1770	1894	2435	2630	--	--	--	--	--	--	--	--	--	--	--	--
		(7.87)	(8.42)	(10.83)	(11.70)	--	--	--	--	--	--	--	--	--	--	--	--

**Allowable lateral load = 1905lbs (8.47kN) (Applicable to all form sizes).**

1kN = 224.8lbs = 102Kg

- Minimum steel ledger specification is Fy=33ksi (230MPa) and Fu=45ksi (310MPa) in accordance with CSA S136-94.
- No load duration increase is allowed.
- Spacing is based on vertical load only.
- For steel ledger, spacing is based on a combination of ledger gauge & anchor bolt diameter. Spacing is closer for a 14 gauge ledger in order to achieve the equivalent bolt/ledger capacity.
- Minimum concrete compressive strength, f'c, is 2500psi (17.25MPa).
- The designer may specify different spacing based on the load requirements.
- For more information contact Simpson Strongtie at [www.simpsonstrongtie.com](http://www.simpsonstrongtie.com)

**Note:** Industry studies show that hardened fasteners can experience performance problems in wet environments. Accordingly, use this product in dry environments only. In addition, due to its corrosive nature, treated lumber should not be used with Simpson Strongties.

### 2.13.5 – TRANSITION LEDGE

A transition ledge typically occurs at the floor level where a wider Element wall transitions to a narrower Element wall above the floor line, and usually up to the roof line.

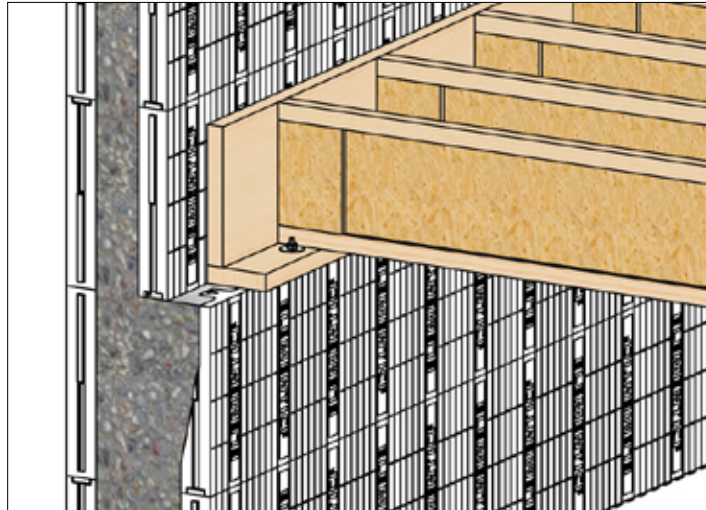

The ledge created when transitioning from a wider to a narrower wall can provide a suitable bearing length for many types of floor systems. The bearing length will vary depending on the thickness and type of Element blocks used. For a complete list of bearing lengths see Section 5.6.1, Bearing Lengths.





### 2.13.5.1 – TRANSITION LEDGE WITH CORNER BLOCKS

Transitioning from a wider block to a narrower block is commonly used in cases where a thinner wall becomes more economical (i.e., below grade wall to above grade wall), or to create a ledge that can support a floor or roof system, or finishes such as brick veneer.

When transitioning at corner locations using corner blocks, you might find that the interlocking knobs on the top side of the wider bottom block (bottom course) do not interlock or align with the underside of the top narrower block (top course). As a result, the top course will not sit or snap into its proper position.

This typically occurs in transitions at corner locations, and is easily resolved by following a few simple steps outlined below.

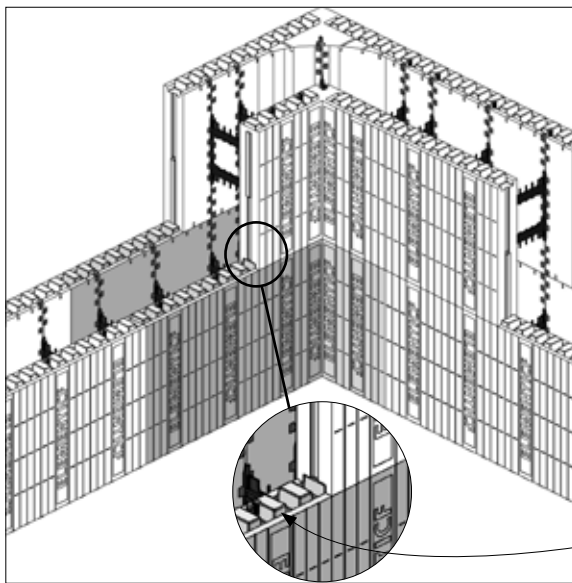

Proper alignment of top course to bottom course. Interlock aligns with underside of top course.

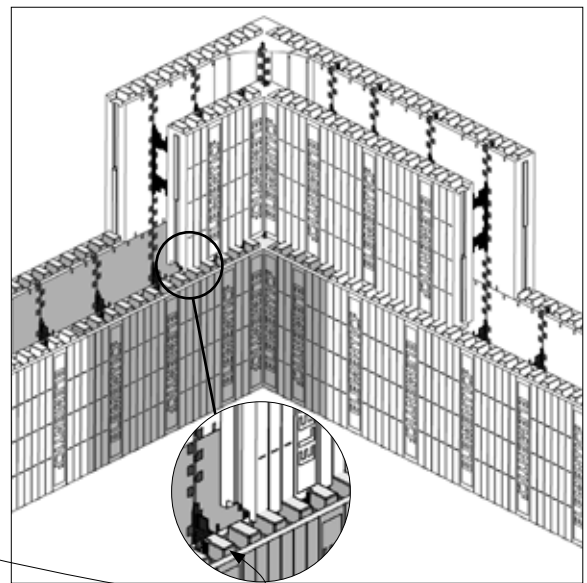

Improper alignment of top course to bottom course. Interlock does not align with underside of top course.

Interlocks

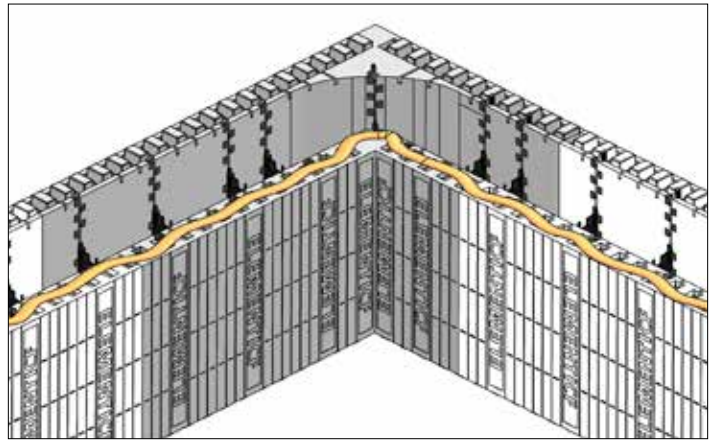
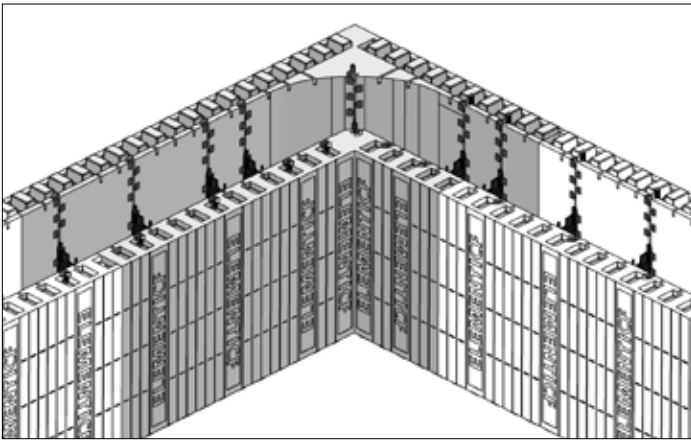

**STEP 1:** Cut the interlocks off the wider corner blocks (it may be necessary to cut the interlocks off the rest of the blocks on the bottom course to ensure the top course can be placed flush on top of the previous course).

**STEP 2:** Apply foam adhesive prior to installing the top course.

As an alternative, Taper Top blocks for the bottom course can be used. The Taper Tops provide more flexibility since they can be adjusted to ensure the interlocks align with the top course.

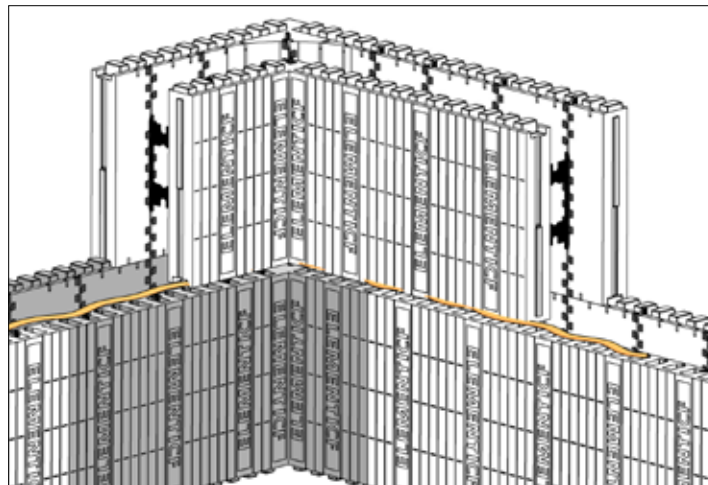

**STEP 3:** Install the top course beginning with the corner block and continuing around the building perimeter.

**2.13.6 – TAPER TOP WITH SILL PLATE**

The Taper Top block creates a greater bearing surface at the top of Element walls.

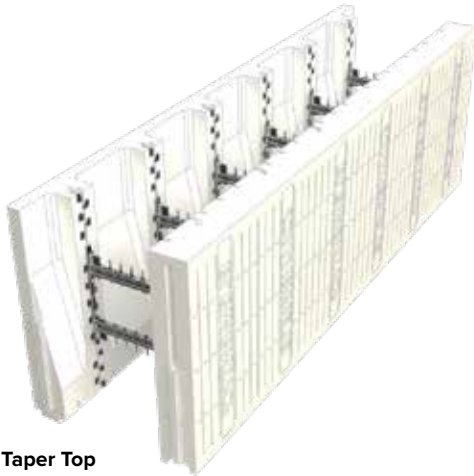

Element Taper Top

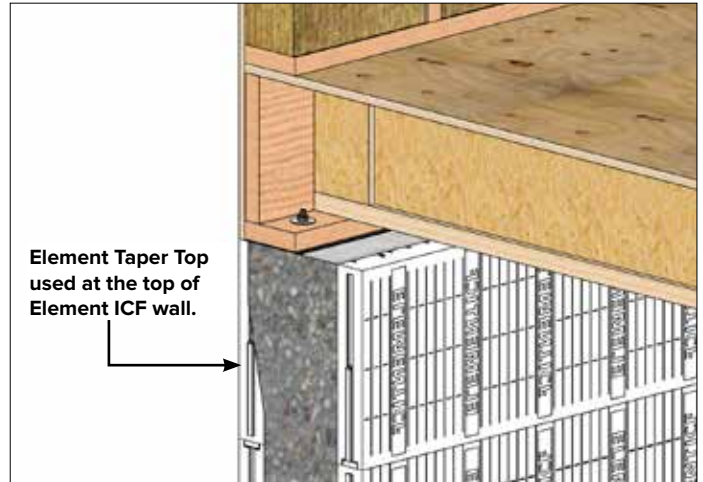

Element Taper Top used at the top of Element ICF wall.

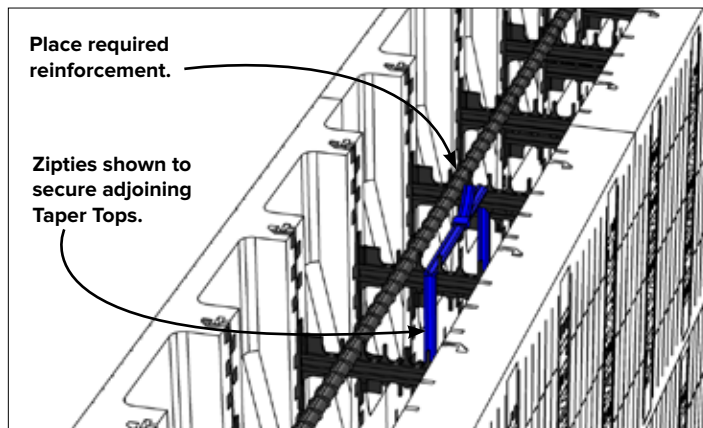

Place required reinforcement.

Zipties shown to secure adjoining Taper Tops.

STEP 1: Taper Top blocks need to be foamed down or otherwise secured to the course below.

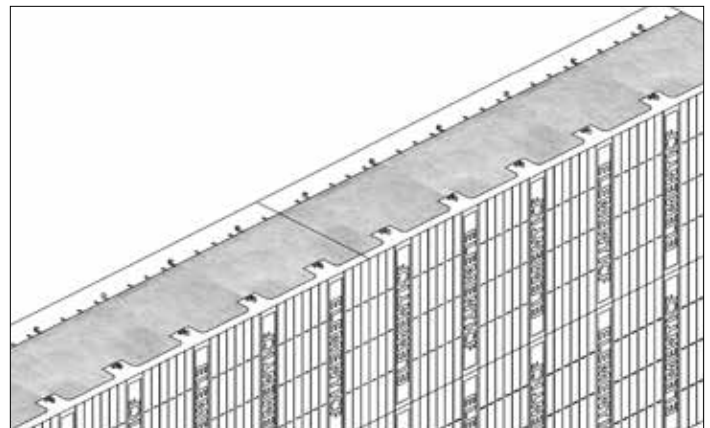

STEP 2: Trowel concrete flush with top of blocks, or inset as required. Be sure to check for level.

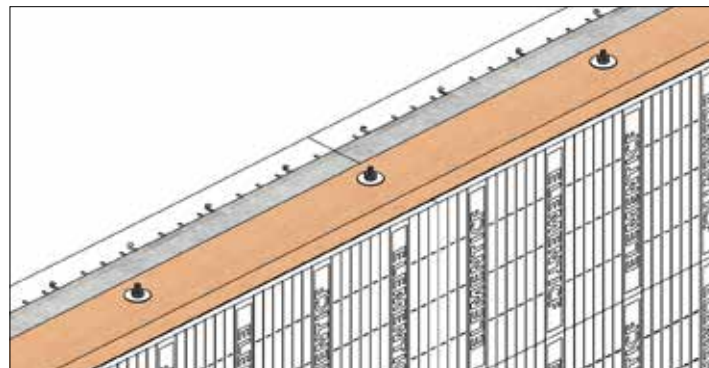

STEP 3: Insert embedments as required.

### 2.13.7 – CONCRETE FLOOR SYSTEMS

Building with Element will allow you to explore many concrete floor system options. Our walls are stronger and can support added weight that wood or steel frame buildings may not. Concrete floor systems are very popular in multi-residential buildings where the transmission of sound and fire are a concern. They are also growing in popularity in single-family residential applications.

#### 2.13.7.1 – PRECAST CONCRETE FLOORS

Pre-cast floor systems are poured at the factory and shipped to site then craned in place. They are usually tensioned with steel cables cast in the concrete to provide maximum strength. Pre-cast floor are fast and can have very long clear spans.

Typically the Element wall is constructed to the desired height and the pre-cast planks sit directly on the cured concrete. The planks, typically 4 feet (1.220 m) wide, are craned in place and the grooves between planks are grouted together. A two inch (52 mm) topping is poured over the deck to provide a smooth and level finish.

The reinforcing of the wall is tied to the grouted grooves to secure the floor in place. The vertical reinforcing of the wall is extended past the planks to secure future levels of Element.

See floor manufacturer for specific installation requirements and details.

INSTALLATION GUIDE - FLOOR CONNECTIONS

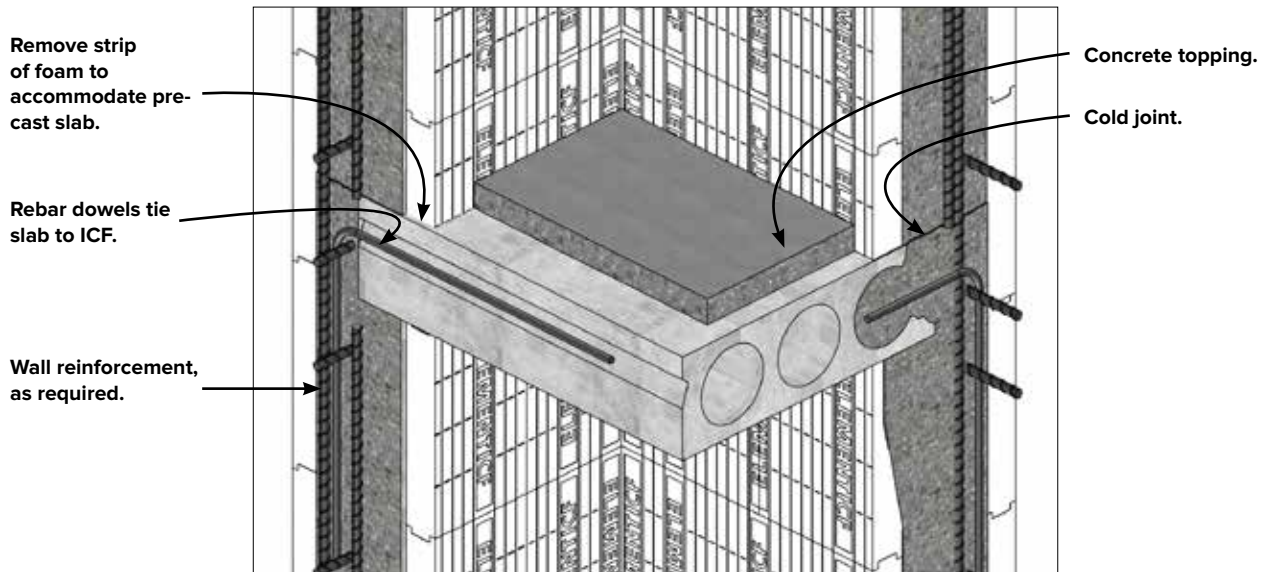

Element ICF with precast slab (hollow core slab example).

**2.13.7.2 – COMPOSITE FLOOR SYSTEMS**

Composite floors are a combination of steel and concrete that is bonded together to create a very strong floor allowing for longer spans and wider joist spacings.

There are a number of brands designed for ICFs including Hambro, iSpanEcospan and Total Joist. Consult your floor manufacturer and your local design engineer for more information.

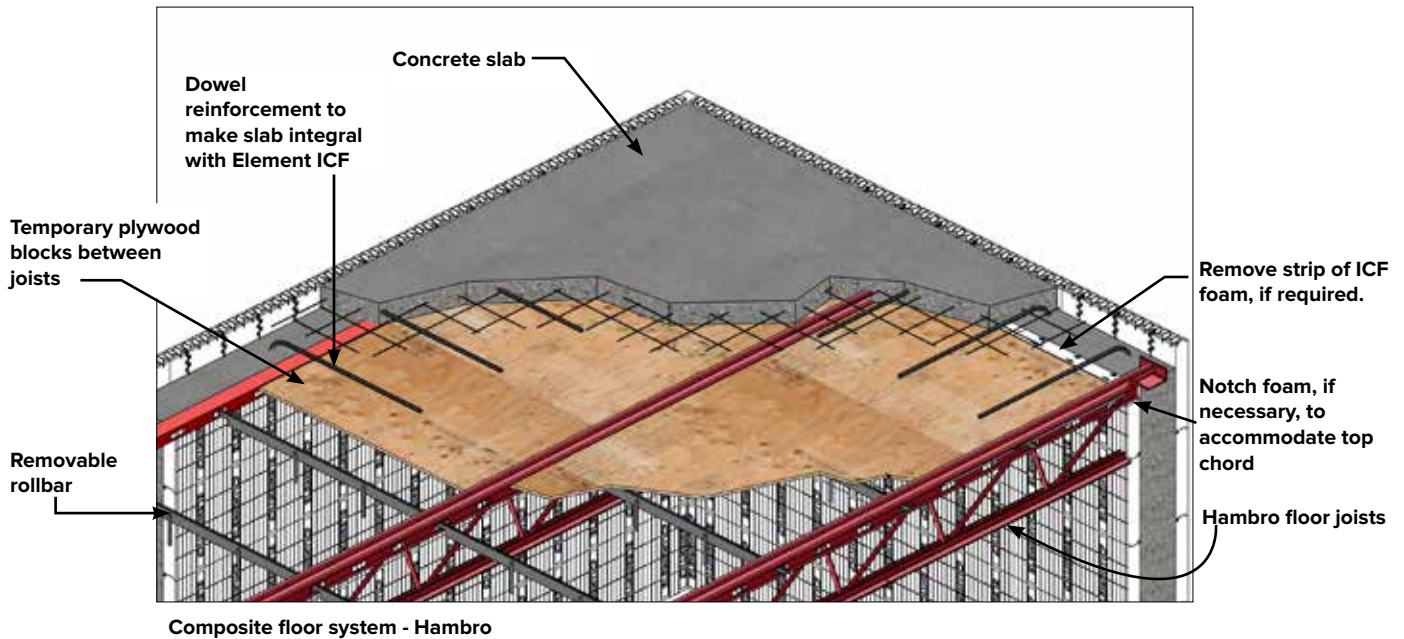

## 2.14 – ROOF CONNECTIONS

Roof connections can be attached to the Element wall in a variety of ways. Several factors can affect which method to use such as area of the country and wind conditions. There are a number of tie-down options made by Simpson Strong-Tie, including brands designed for ICFs, such as Burmon tie-down systems.

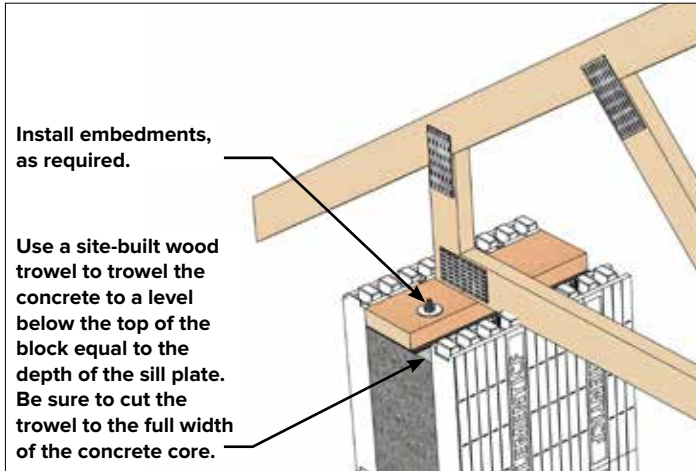

### INSET SILL PLATE

This method of sill plate attachment is the most energy efficient. The Element foam on each side provides an excellent thermal barrier.

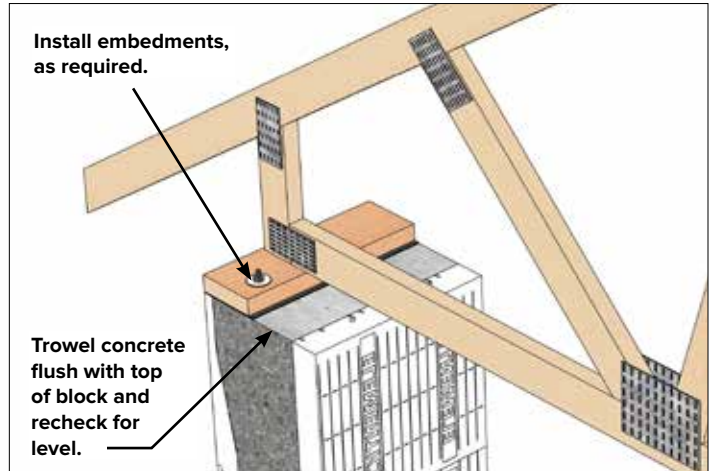

### TOP MOUNTED SILL PLATE

This method is typically used when additional wall height is required.

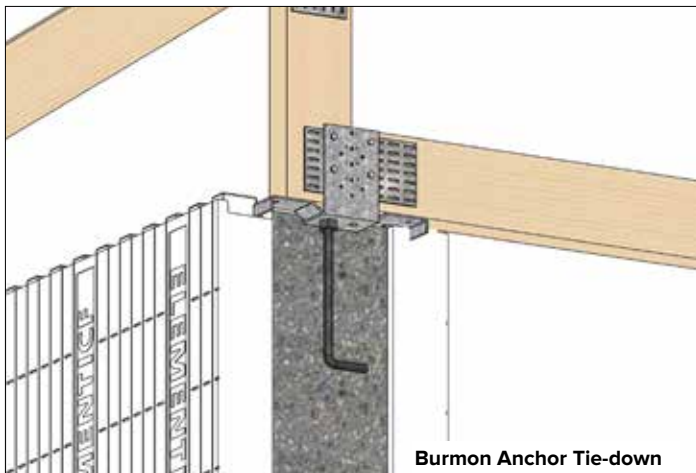

### TIE-DOWN TO CONCRETE

This method anchors the roof truss to the concrete.

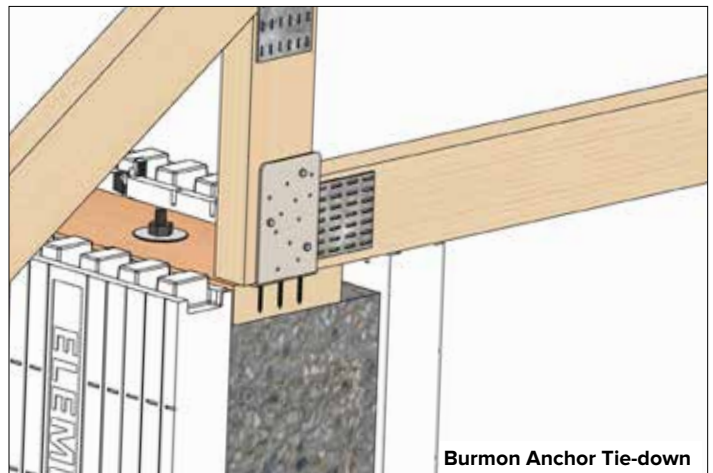

### TIE-DOWN TO SILL PLATE

This method anchors the roof truss to the sill plate. (Burmon Anchor Tie-down)

INSTALLATION GUIDE - ROOF CONNECTIONS



## 2.15 – SERVICE PENETRATIONS

Identify and size all service and utility penetrations. Install all appropriate and properly sized sleeves where required, remembering that lightweight sleeves can be crushed during concrete placement.

List of possible service penetrations

- Dryer vent
- Water heater vent
- Water
- Sewer
- Electrical main service
- Gas line
- A/C line
- Furnace vent
- Air Exchange/HRV
- Central vacuum
- Ducting
- Bathroom vent
- Kitchen appliance venting
- Fireplace rough opening and vent
- Pet door

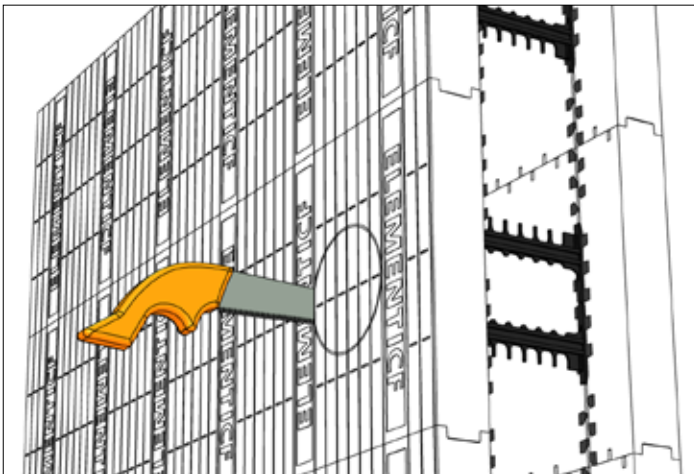

Cut appropriate sized holes for penetrations.

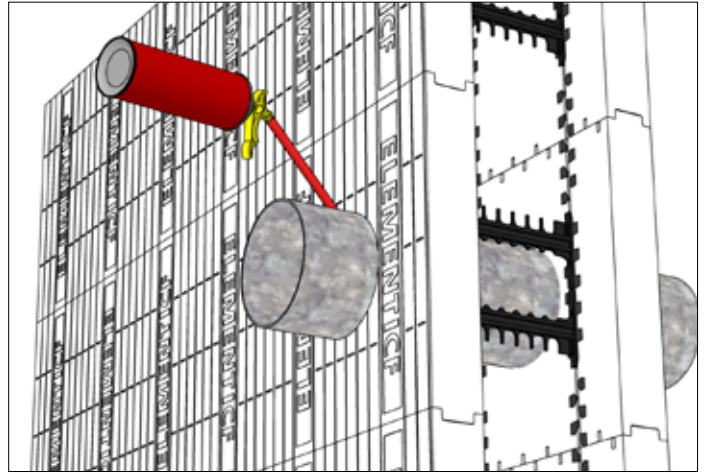

Install all required services through the ICF prior to concrete placement, and secure with spray foam.

## 2.16 – CONCRETE PLACEMENT

### 2.16.1 – PRE-PLACEMENT CHECKLIST

DATE:  
FOREMAN:  
JOB:

Prior to placing concrete in Element insulated concrete blocks, be certain to mark off each item on the checklist provided in this section.

- 1. String line in place around the top of entire perimeter?
- 2. Walls straight and plumb (not leaning out)?
- 3. Top course foamed or tied down with zip ties or Element Hooks end to end to maintain dimensions?
- 4. Additional block support on all corners?
- 5. Have Tee-walls been foamed and supported?
- 6. Alignment - screw in every course?
- 7. Scaffold planking properly secured?
- 8. All handrails and toe boards installed?
- 9. All bucks cross braced?
- 10. All bucks secured to wall?
- 11. All buck concrete anchors installed?
- 12. All horizontal and vertical rebar in place?
- 13. All lintel reinforcing in place?
- 14. All penetrations installed?
- 15. All beam pockets in place?
- 16. All floor embedments installed?
- 17. Are anchor bolts and hold-downs on site?
- 18. Has cavity of wall been checked, and foreign material removed?
- 19. Plywood, screw gun, and saw on site?
- 20. Interlock protected by tape, or other covering?
- 21. Proper concrete mix and slump ordered?
- 22. Concrete vibrator on site?
- 23. Pump equipped with reducer or 2 1/2" trimmer hose available?





**2.16.2 – MIX DESIGN**

Minimum compressive concrete strength is typically 3,000 psi (20MPa) at 28 days. However, this will depend on the structure and loading conditions. For seismic areas mix design should be confirmed with local codes or by an engineer.

The following maximum aggregate sizes are recommended for use in Element walls:

	Block Cavity Size, in. (mm)				
	4 (102)	6.25 (159)	8 (203)	10 (254)	12* (305)
Max. Aggregate Size, in. (mm)	3/8 (9.5)	3/8 (9.5) to 1/2 (13)	3/4 (19)	3/4 (19)	3/4 (19)

Always consult your local ready mix companies for appropriate concrete mix design.

### 2.16.3 – BEST PRACTICES

The most important stage of a successful Element project is the concrete placement. Extra workers at this stage are important - be certain to have enough on hand during the pour to safely handle placement, consolidation, alignment, embedments, and cleanup.

An experience crew ensures the concrete is properly placed and consolidated. The following are recommended practices and considerations when placing concrete.

- Concrete slump should be 5 inch (127 mm) to 6 inches (152mm) for best results.
- Use an internal vibrator with a head size of 3/4 inch (19 mm) to 1 inch (25mm) and maximum 1 hp motor. Do not use a vibrator with a head larger than 1 inch (25 mm).
- Appropriate internal vibration assures the strongest walls possible and is especially important for below grade application where the greatest loads occur.
- The rule of thumb for internal vibration is fast in and slow out, always moving, with a withdrawal rate of approximately 3 inch (76 mm) per second. Other methods of placement include conveyor truck, crane and bucket, and directly off the ready mix truck.
- Lift height is determined by many factors, such as air temperature, concrete temperature, slump, etc. In general, lift heights should not exceed 4ft (1.220 m) per hour.
- When placing concrete below freezing or at temperatures above 100° F (38° C), it's important to protect all exposed concrete with insulation.
- When placing concrete in 4 inch (102 mm) blocks, it is recommended that the pump truck be fitted with a 2.5 inch (76 mm) flexible hose end.

**2.16.4 – PLACING CONCRETE**

Once the pre-placement checklist is finished, adhere to the following guidelines during the concrete placement process.

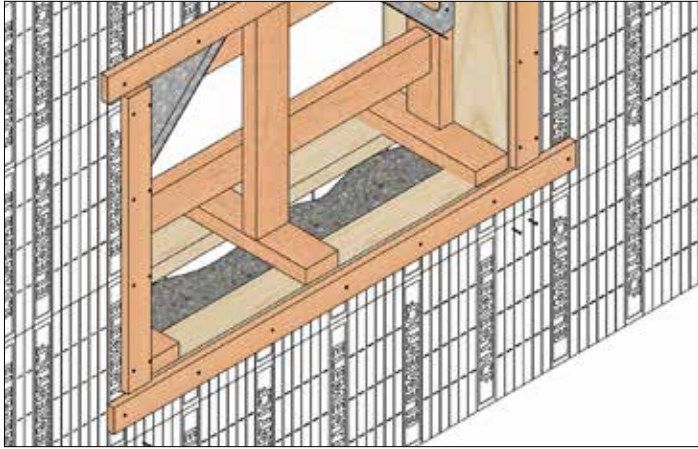

**STEP 1:** Begin concrete placement under openings, filling those areas and consolidating.

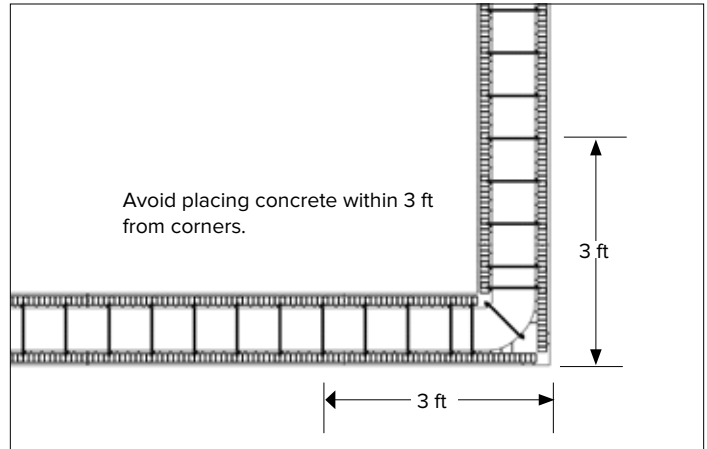

**STEP 2:** Beginning no closer than 3 feet (0.914 m) from a corner, start filling the wall from the top, allowing the concrete to flow gently toward the corner. Then fill in that corner from the opposite side using the same technique.

**STEP 3:** Continue placing concrete around entire wall in appropriately sized lifts, using the same technique at each corner to minimize fluid pressure.

**STEP 4:** Vibrate the concrete as it is being placed to ensure proper consolidation.

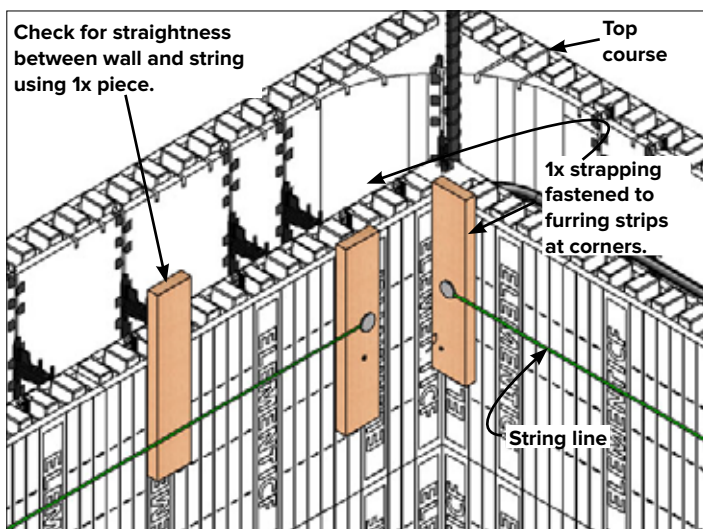

**STEP 5:** Check and adjust wall alignment using string lines and turnbuckles.

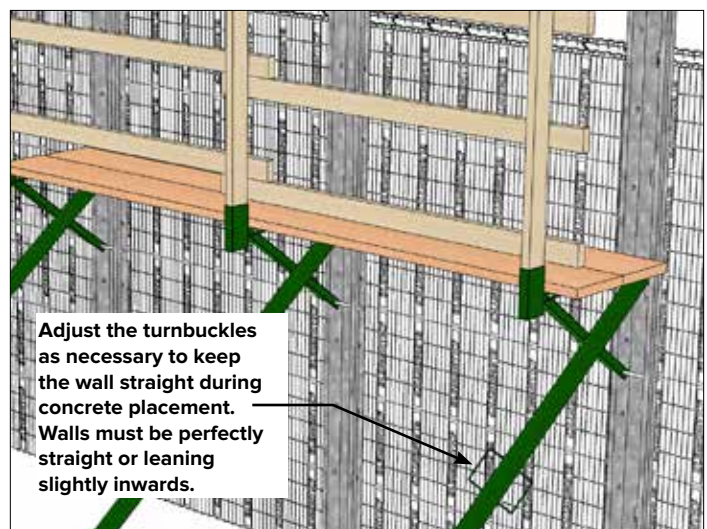

**STEP 6:** Return to starting location and begin the next lift. Follow all the techniques established above.

## 2.16.5 – POST-PLACEMENT CHECKLIST

DATE:  
FOREMAN:  
JOB:

After placing concrete in Element insulated concrete blocks, be certain to mark off each item on the checklist provided in this section.

- 1. Has consolidation been completed?
- 2. Are walls straightened to string line?
- 3. In extreme temperatures, has exposed concrete been protected?
- 4. Have all anchors and embeds been installed?
- 5. Has spilled concrete been disposed of?
- 6. Has final check for straight and plumb been done?



## 2.17 – ELECTRICAL INSTALLATIONS

Electrical and plumbing installation are typically performed after concrete placement. The exception to this rule is the placement of conduit that penetrates the wall, which must be performed before concrete placement.

Installing electrical wiring and boxes is accomplished by creating channels in the EPS foam. When installed in Element walls directly against the concrete, electrical boxes will extend 1/2 inch (13 mm) beyond the foam to match the thickness of 1/2 inch (13 mm) sheetrock.

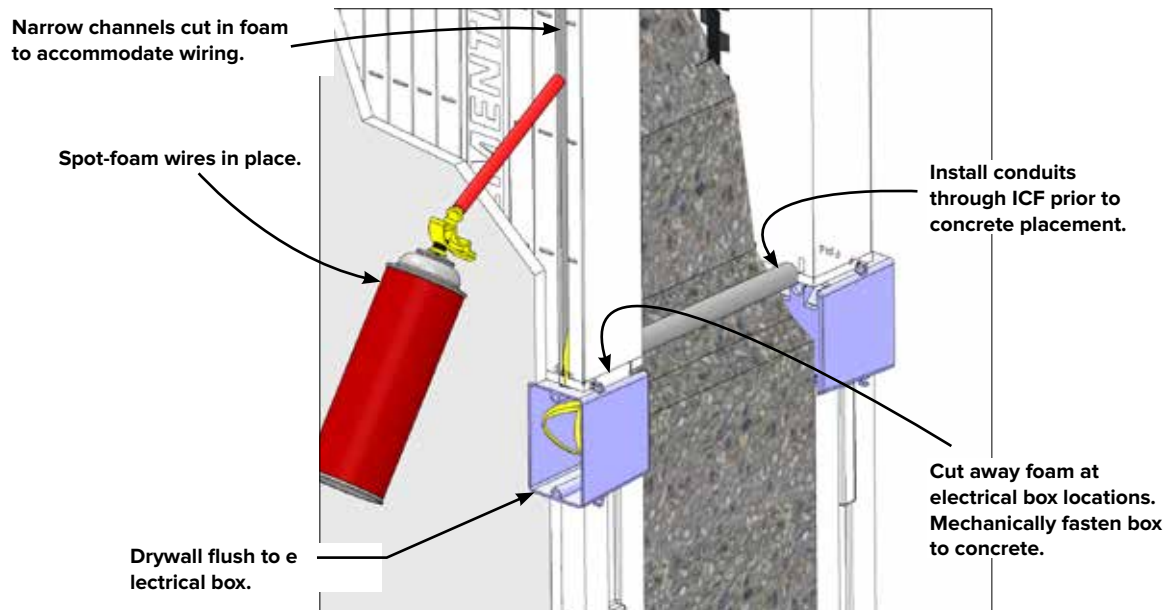

Various tools can be used to create the channels and spaces for wiring and boxes:

- Electrical chainsaw with an adjustable roller depth stop
- Hot knife
- Circular saw with a masonry blade

Make the wiring channels narrow so there will be a friction fit with the wiring. The wiring needs to remain embedded well into the foam to meet local electrical codes. Foam adhesive can be spot-applied into the channel to help hold the wiring in place.

Both preformed and site-assembled Element blocks are engineered to create wire chases between courses every 16 inches on center vertically, eliminating the need to cut the embedded furring strips.

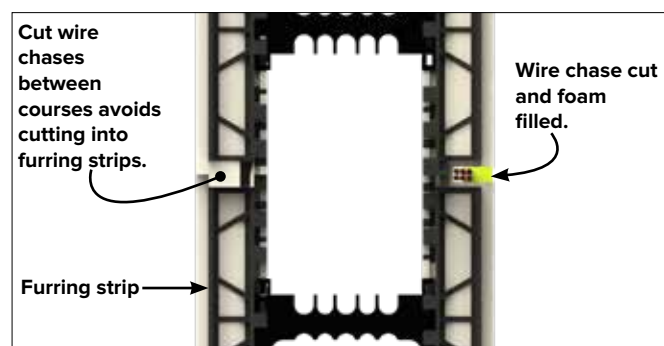

## 2.18 – PLUMBING INSTALLATIONS

In most cases, buildings are designed so plumbing pipes are not carried through the Element walls, except for utility entry and exit points.

However, in some cases it may be required to embed pipe in the EPS. For example, a kitchen vent tube may need to be installed vertically in the EPS foam. Pipes embedded in the foam cannot exceed 1-1/2 inch (38 mm) in diameter. Fittings embedded in the foam cannot exceed 2-1/2 inch (64 mm) diameter.

An external faucet will require the installation of a hose sleeve through the wall prior to concrete placement. This will permit replacement of the faucet or pipe should it ever be necessary.

If connecting to existing sewer lines, establish the location of the required opening and ensure clearances, since this is difficult to change.

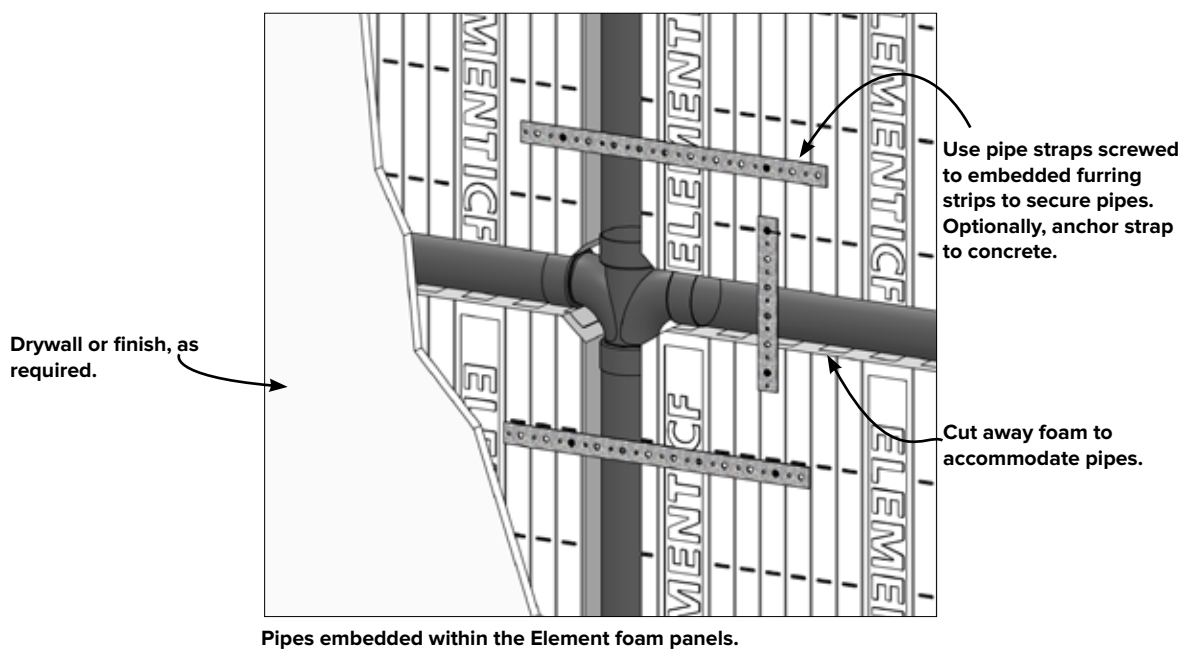



## 2.19 – INTERIOR & EXTERIOR FINISHES

### 2.19.1 – VAPOR & AIR BARRIERS

The Element wall assembly has no need for an additional vapor barrier, the solid concrete core covered with the low permeance EPS foam insulation on the inside wall face keeps water vapor from penetrating the wall.

The fact that the inner face of EPS foam maintains a similar temperature as the inside air of the building and that an Element wall has no cavity means that no condensation can occur in an Element wall assembly.

The Element wall assembly has no need for an air barrier (building wrap) layer as the solid concrete core and low permeance EPS foam insulation on the outside wall face keeps air and moisture from penetrating the wall.

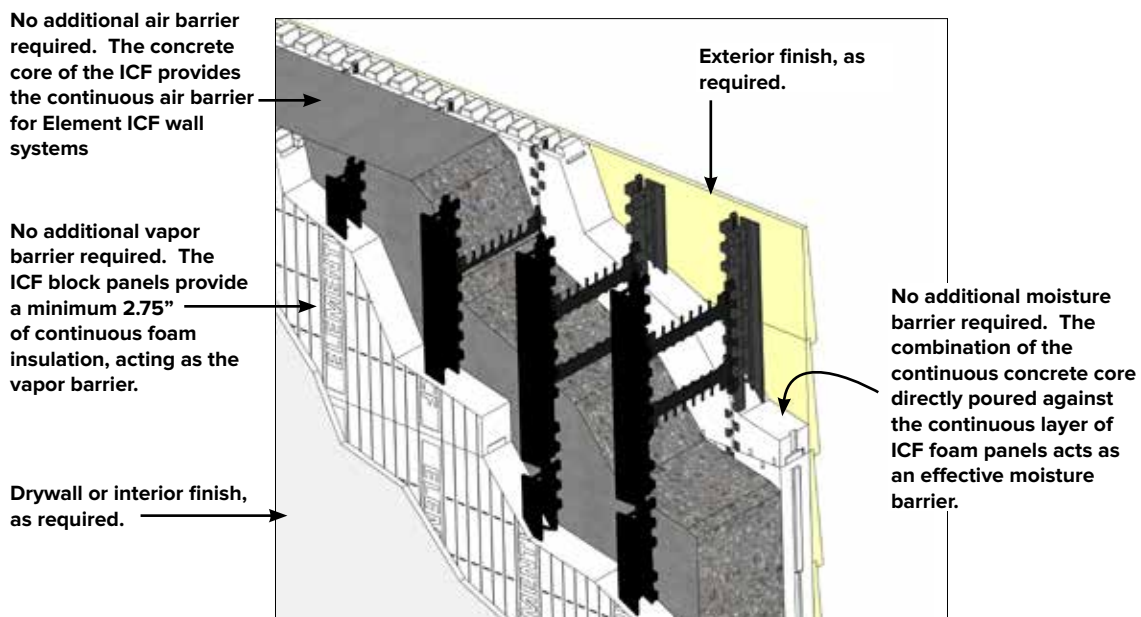

No additional air barrier required. The concrete core of the ICF provides the continuous air barrier for Element ICF wall systems

No additional vapor barrier required. The ICF block panels provide a minimum 2.75" of continuous foam insulation, acting as the vapor barrier.

Drywall or interior finish, as required.

Exterior finish, as required.

No additional moisture barrier required. The combination of the continuous concrete core directly poured against the continuous layer of ICF foam panels acts as an effective moisture barrier.

Typical Element wall assembly - no additional vapor barrier, house wrap and air barrier required.

INSTALLATION GUIDE - INTERIOR & EXTERIOR FINISHES

**2.19.2 – INTERIOR DRYWALL**

Drywall should be installed in the same manner on an Element wall as on a stud wall, with the following time-saving exceptions:

- All furring strips (studs) are on 8 inch (203 mm) centers from floor to ceiling for easy attachment of any type of interior wall finish.
- The butt joints of the sheetrock do not need to fall on webs (studs) as the foam provides solid backing wherever the joints fall. However, the edge of sheetrock panels should not exceed more than 4” from webs.
- A foam-compatible adhesive can be used to effectively fasten the sheetrock to the Element wall along with screws. Always make sure to verify the local code for types and spacing for sheetrock fasteners. Typically, adhesive alone is not allowed as a fastener of sheetrock, but again check with local building codes.

Many local building codes require the application of 1/2 inch (13 mm) drywall or other suitable thermal barrier in any living space even though the EPS foam has a fire retardant component. Always verify local building code requirements.

Non-habitable spaces such as crawl spaces, attics, and other types of hidden areas typically do not require a thermal barrier (drywall).

Embedded furring strips are fixed at each corner of the Element 90° corner blocks for solid sheetrock fastening at all corners.

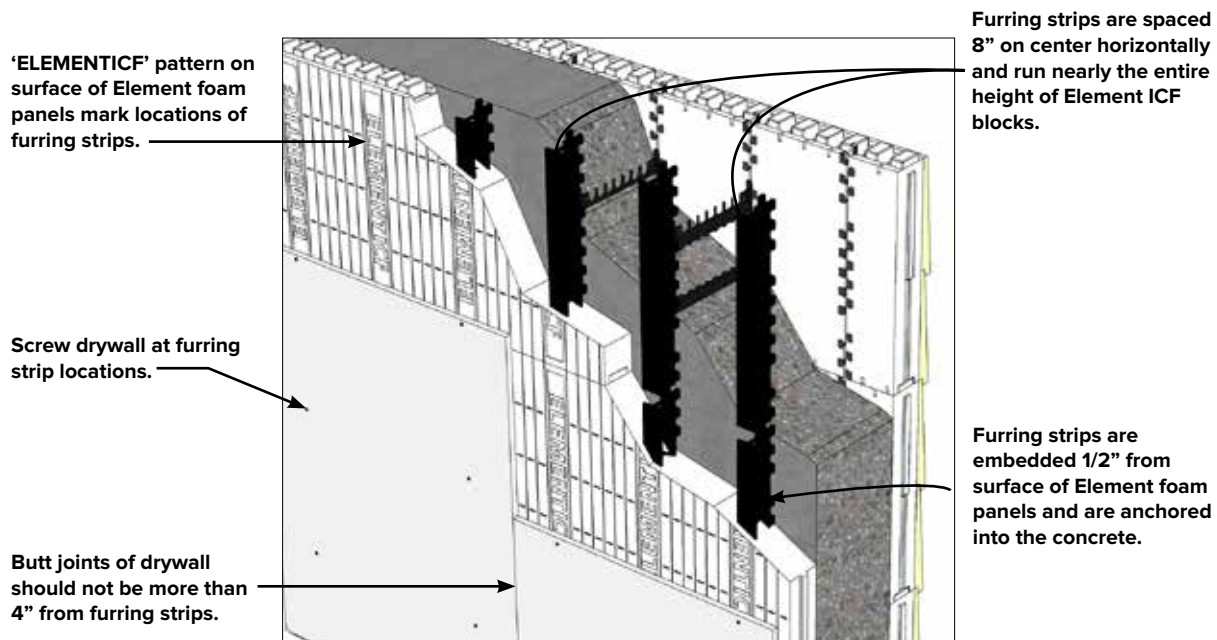

Typical Element wall assembly - Attaching drywall.





### 2.19.3 – EXTERIOR SIDING

Siding material of some kind must be installed over the EPS foam to protect it from the UV rays of the sun. Foam left exposed to the sun will slowly develop a dusty surface.

**NOTE:** When using Element Platinum Series care should be taken to protect exposed foam surfaces from reflected sunlight and prolonged solar exposure until wall cladding or finish material is applied. Shade exposed foam areas, or remove sources of reflective surfaces, where heat build up onto exposed foam might occur. For more information refer to BASF Technical Leaflet N-4 Neopor, “Recommendations for packaging, transporting, storing and installing building insulation products made from Neopor EPS foam.” (The BASF Technical Leaflet is attached to every bundle of Element Platinum blocks delivered to a job site).

Metal and vinyl siding can be installed directly over the top of the EPS.

Although air guns can be used, the use of screw guns is recommended when attaching exterior siding. Always follow manufacturer’s recommendations and local codes to determine the size and spacing of fasteners for all siding products.

Any type of siding that is used on a typical wood-framed building can be used on an Element building.

The siding channel stock around doors and windows can be fastened to whatever type of buck material was chosen, in a similar fashion as wood framed building.

Furring strips are spaced **8”** on center horizontally and run nearly the entire height of Element ICF blocks.

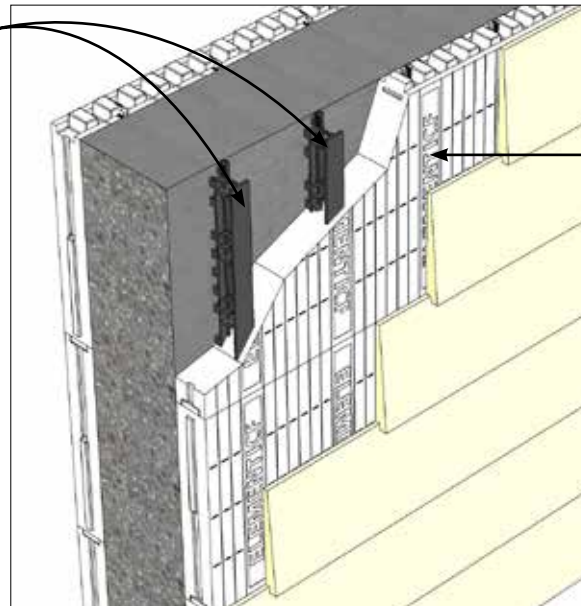

‘ELEMENTICF’ pattern on surface of Element foam panels mark locations of furring strips.

Fasten siding at furring strip locations.

Typical Element wall assembly with siding.

**2.19.4 – STEEL PANEL SIDING**

Steel panel siding can be applied vertically to an Element wall when the style of the panel matches the Element web spacing at 8 inch (203 mm) on center increments for fastening purposes.

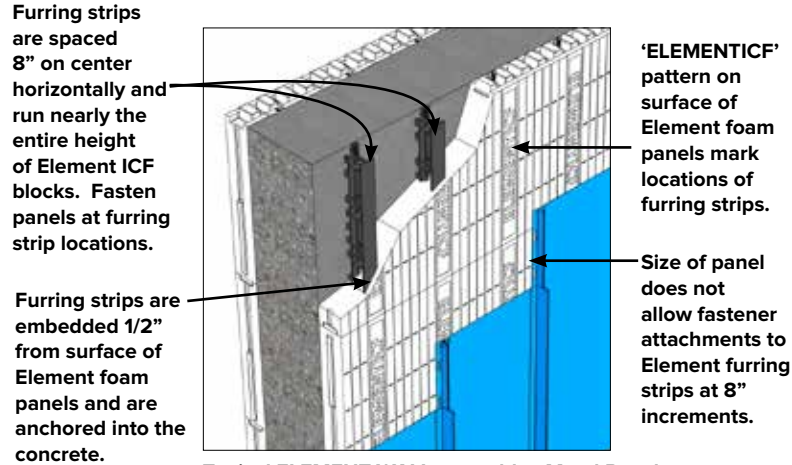

Typical ELEMENT WALL assembly - Metal Panel Siding.

When a panel siding is chosen that doesn't fit with 8 inch (203 mm) increment for fastening, two different methods are available:

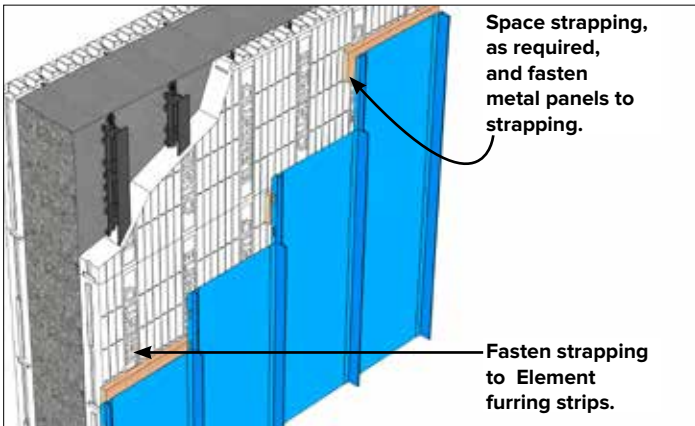

Typical Element wall assembly - Metal Panel Siding with strapping

**METHOD 1:** A 1/2 inch (13 mm) or 3/4 inch (19 mm) strip of wood can be attached horizontally to the webs in the wall to provide the manufacturer's specified fastener spacing.

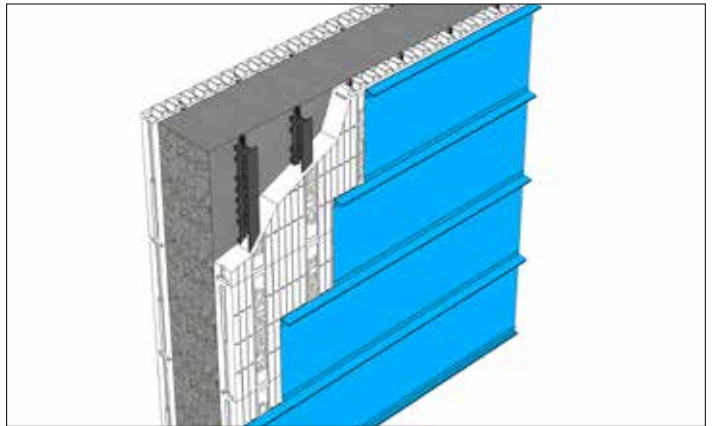

Typical Element wall assembly - Metal Panel Siding placed horizontally.

**METHOD 2:** The panels can be installed horizontally, by fastening directly into the webs.

**NOTE:** Although air guns can be used, screw guns is recommended when attaching to exterior siding. Always follow manufacturer's recommendations and local codes to determine the size and spacing of fasteners for all siding products.



## 2.19.5 – WOOD SIDING

Any wood siding can be attached to the Element wall in the same manner as to a traditional framed building. The spacing of the web studs on 8 inch (203 mm) centers allows for industry standard spacing of fasteners. Typically, screws are used for attaching wood siding or even half-log siding to the Element wall .

Although air guns can be used, a screw gun with screws in clips (Quik Drive) is recommended. This is usually the fastest method for applying wood siding. Always follow manufacturer's recommendations and local codes to determine the size and spacing of fasteners for all siding products.

A good practice for installing wood siding on a wall, is to apply the siding over vertical 1 inch x 2 inch (25 mm x 51 mm) wood nailing strips with a screen at the bottom. The screen keeps insects out while the space allows air to circulate behind the siding. The air circulation helps equalize the moisture content in the wood siding, which makes for much more dimensionally stable siding and longer lasting application.

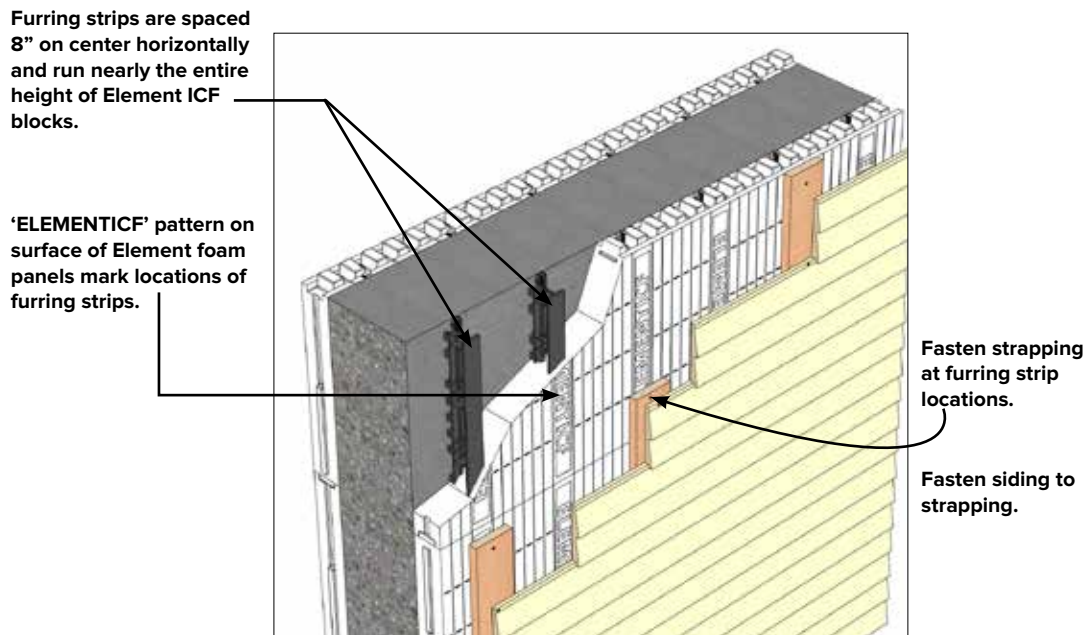

Typical Element wall assembly - Wood Siding.

**2.19.6 – EIFS**

There are now acrylic-based stucco products available that are more flexible and easier to work with than traditional cement-based stucco. Collectively these products are known as EIFS (Exterior Insulation Finish Systems) and almost always require an EPS substrate.

Because Element blocks are made with EPS, they are a natural fit for EIFS finishes. In addition, the webs in Element blocks are embedded 1/2 inch (13 mm) deep in the EPS foam to comply with EIFS manufacturer requirements.

It is important to follow the EIFS manufacturer’s application procedures.

INSTALLATION GUIDE - INTERIOR & EXTERIOR FINISHES

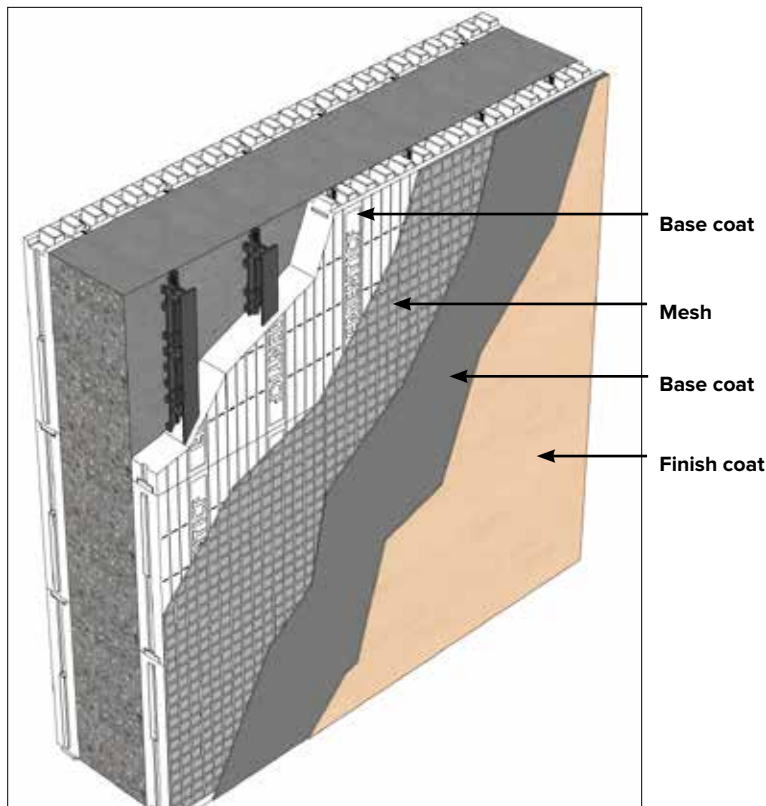

Typical Element wall assembly - EIFS example. Consult EIFS manufacturer for recommended application procedures.

**2.19.7 – CEMENT COMPOSITE SIDING**

Recently the new cement fiber siding products have gained popularity. This type of siding can usually be fastened directly to the Element webs.

Although air guns can be used, a screw gun is recommended to fasten flat-headed exterior screws at 16 inch (406 mm) centers. The screws pull the siding in tight and hold the siding securely in place.

Some manufacturers may require the siding to be strapped out to allow air space behind. Vertical or shake patterns will require strapping for fastening. See illustrations in Section 2.19.4 and 2.19.5 for strapping examples.

Always follow manufacturer’s recommendations and local codes to determine the size and spacing of fasteners for all siding products.

Check with your siding manufacturer for specific requirements.

Furring strips are spaced 8” on center horizontally and run nearly the entire height of Element ICF blocks.

Furring strips are embedded 1/2” from surface of Element foam panels and are anchored into the concrete.

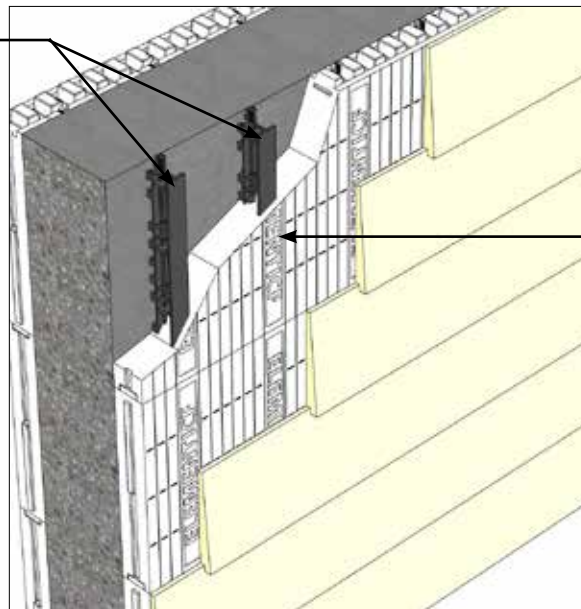

‘ELEMENTICF’ pattern on surface of Element foam panels mark locations of furring strips.

Fasten siding at furring strip locations.

Typical Element wall assembly - Cement fibre siding installed horizontally.

**2.19.8 – BRICK VENEER**

The Element Brick Ledge block units are used to support a brick veneer as the exterior finish material. The Brick Ledge blocks are simply placed at a level where the brick is desired to begin. The design of the block creates a reinforced concrete ledge.

With standard reinforcing, the Brick Ledge can bear up to 1300lb/ft (19kN/m) of wall. With site-specific engineering, up to 3000lb/ft (44kN/m) of wall is attainable.

To install Brick Ledge block units, follow the instructions in section “2.8.5 – CORNER BRICK LEDGE and taper tops” on page 26 of the guide. When reinforcing steel and concrete are in place within the wall, brick is laid on the ledge and tied back to the webs with brick ties as specified.

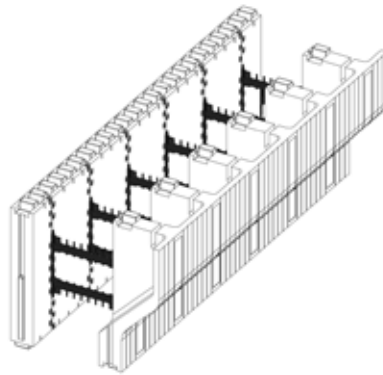

INSTALLATION GUIDE - INTERIOR & EXTERIOR FINISHES

**STIRRUP DETAILS**  
(Refer to Element Brick Ledge Stirrup Dimensions Table)

**ELEMENT BRICK LEDGE STIRRUP DIMENSIONS**

	BRICK LEDGE SIZE				
	4"	6"	8"	10"	12"
A	8" [203mm]	9.7" [246mm]	11.6" [295mm]	13.4" [340mm]	15.25" [387mm]
B	40°	44°	48°	50°	52°
C	115°	110°	106°	104°	103°

**NOTES:**  
1. Refer to the Element Prescriptive Engineering for reinforcement design.

**ELEMENT ICF**  
LOGIX BRANDS

Copyright Logix Brands Ltd. (Use of Publishing) All rights reserved. No part of this copyright may be reproduced or used in any form, or by any means, graphic, electronic or mechanical, including without limitation photocopying.

By using these drawings, you agree to assume all risk associated therewith. See logixbrands.com/Disclaimer-Drawings for a full copy of disclaimer.

Drawing: 5.14.4.2 Date: Mar 03/23 Pg: 1/1  
Title: ELEMENT BRICK LEDGE - STANDARD REINFORCEMENT STIRRUP DETAILS

ElementICF.com A Product By Logix Brands Ltd. 1-866-944-0153

**STUD DETAILS**  
(Refer to Element Brick Ledge Stud Dimensions Table)

**ELEMENT BRICK LEDGE STUD DIMENSIONS**

BRICK LEDGE SIZE	STUD DIMENSIONS				
	4"	6"	8"	10"	12"
A	8.13" [206mm]	11.13" [282mm]	13.13" [333mm]	15.13" [384mm]	17.13" [435mm]

**NOTES:**  
1. Specifications and material properties shown in DBA document image below. Recommend SWP Part# DBA 38 1818 (refer to DBA chart below).  
2. Refer to the Element Prescriptive Engineering for reinforcement design.

**DBA DEFORMED BAR ANCHORS**

**ELEMENT ICF**  
LOGIX BRANDS

Copyright Logix Brands Ltd. (Use of Publishing) All rights reserved. No part of this copyright may be reproduced or used in any form, or by any means, graphic, electronic or mechanical, including without limitation photocopying.

By using these drawings, you agree to assume all risk associated therewith. See logixbrands.com/Disclaimer-Drawings for a full copy of disclaimer.

Drawing: 5.14.4.3 Date: Mar 03/23 Pg: 1/1  
Title: ELEMENT BRICK LEDGE - HEAVY REINFORCEMENT STIRRUP DETAILS

ElementICF.com A Product By Logix Brands Ltd. 1-866-944-0153

2/25/2024 12:36:21 PM

2/25/2024 12:36:08 PM



## 2.19.9 – BELOW GRADE WATERPROOFING, DAMPPROOFING & PARGING

There are many methods available to protect the “below grade” and the “just above grade” areas of the exterior of your building.

Dampproofing is used on concrete or masonry surfaces to repel water in above grade walls. The 2.75 inch (70 mm) foam panels of the Element insulated concrete blocks act as dampproofing, therefore, no additional dampproofing treatment is required.

**NOTE:** Although dampproofing above grade walls is not typically required, check with local building codes for dampproofing requirements.

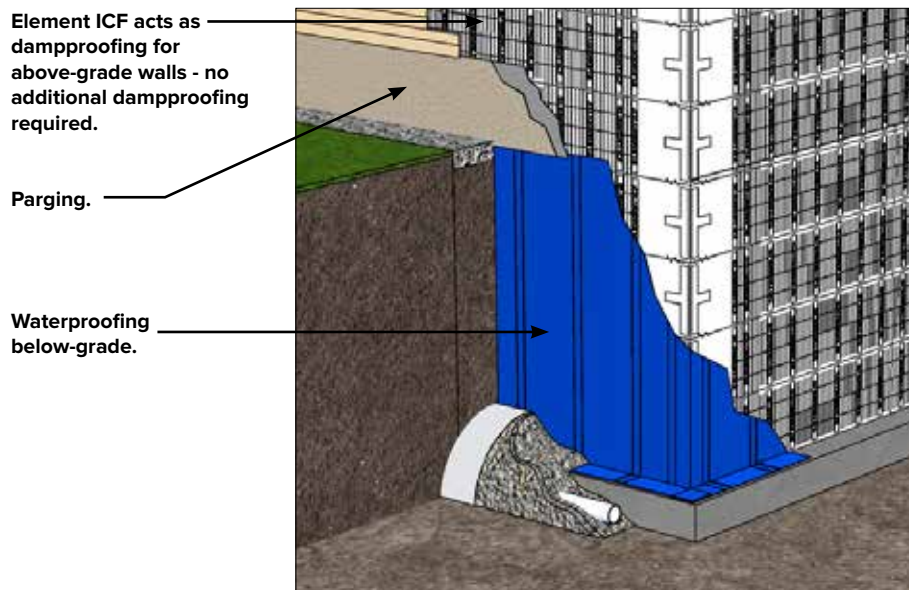

### 2.19.9.1 – BELOW GRADE WATERPROOFING

A rubberized “peel and stick” waterproofing membrane is recommended for waterproofing below-grade. The membrane is applied vertically to the wall from grade level down to and overlapping the top of the footing. It is recommended to use protection board, such as 1/2 inch rigid foam boards, or drainage boards, to prevent damage to the waterproofing membrane during backfilling.

Proper free-draining backfill material is recommended for below-grade walls.

**NOTE:** Membrane should be installed within one week prior to backfill being placed. Sunlight and high temperatures may cause the membrane to begin to “sag” which may cause wrinkles in the material. This may result in tears or punctures during the placement of the backfill material. Should you choose to use one of the many other types of waterproofing available be sure to follow the manufacturer’s recommended installation procedures.

### 2.19.9.1 – BELOW GRADE WATERPROOFING

**STEP 1:** Prep the wall and footing area to be covered by removing all dirt and debris. If the ICF foam panels have been subjected to prolonged UV exposure a chalky layer of dust will develop on its surface. Be sure to remove the dust layer by sweeping the surface with a broom.

**STEP 2:** Snap chalk lines for the “grade” line.

**STEP 3:** Measure the height from grade line to footing. Add enough length to cover the top of the footing and cut pieces of membrane to length.

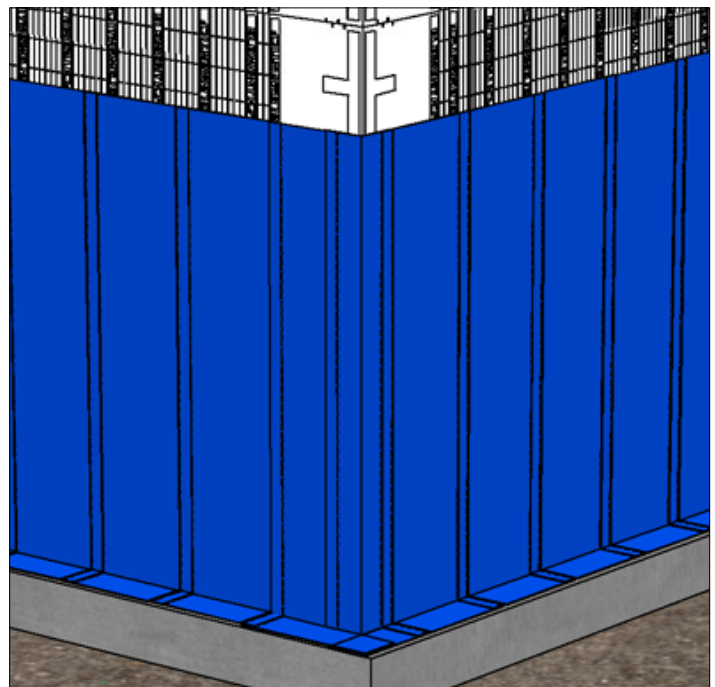
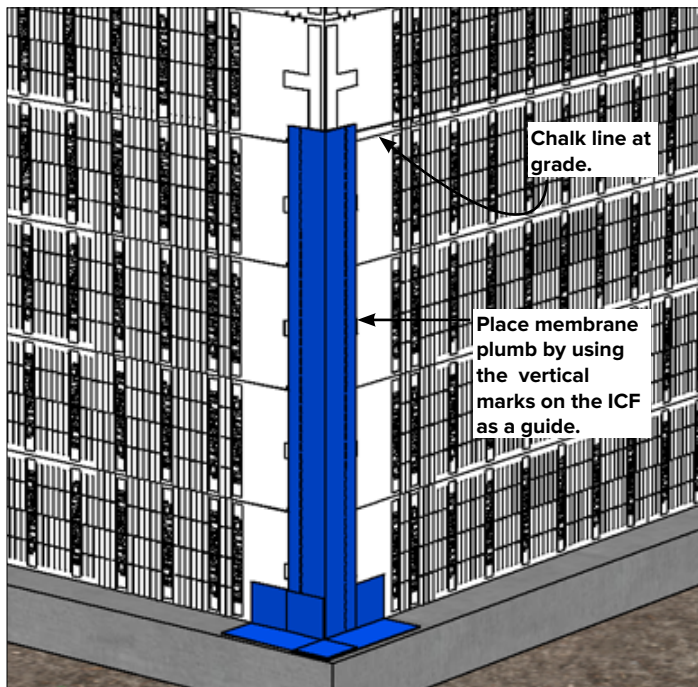

**STEP 4:** Apply the membrane at corners first. Hang the membrane vertically, and starting at the top pull back the first 8” to 10” of the release paper and press. Continue pulling back the release paper and pressing the membrane to the wall. Make sure to wrap the corners with the membrane.

**STEP 5:** Starting at a corner continue applying cut pieces of membrane around the wall, maintaining 2 inch overlap by using the printed marks on the membrane as a guide.

**NOTE:** Extreme temperatures, both cold and hot, may cause the installer to consider other types of waterproofing. Be sure to follow the manufacturer’s installation process.





### 2.19.9.2 – ABOVE GRADE PARGING

The area that is above grade line and below the exterior siding material must be parged to protect the EPS from damage.

Parging is a coating material that is applied to give a finished appearance to the small area of wall that is above grade level but below where the siding materials will begin. Element Prepcoat is the preferred option for this area.

**STEP 1:** Prep the wall area to be covered by removing any dirt or debris. The wall may need to be “scuffed” to reveal fresh EPS beads.

**STEP 2:** Mix Prepcoat dry material with water to a pasty consistency.

**STEP 3:** Using a trowel apply a thin, 1/16” - 1/8” (2mm - 3mm) “skim coat” of Prepcoat.

**STEP 4:** Pre-cut pieces of Element fiber mesh 1” - 2” (25mm - 51mm) wider than the area to be parged. This will allow for an over-lap over the waterproofing membrane to create a “drip ledge”.

**STEP 5:** Embed the mesh in the skim coat firmly.

**STEP 6:** Once the area is dry to the touch apply a second coat of Prepcoat. This coat can be painted or stained if desired.

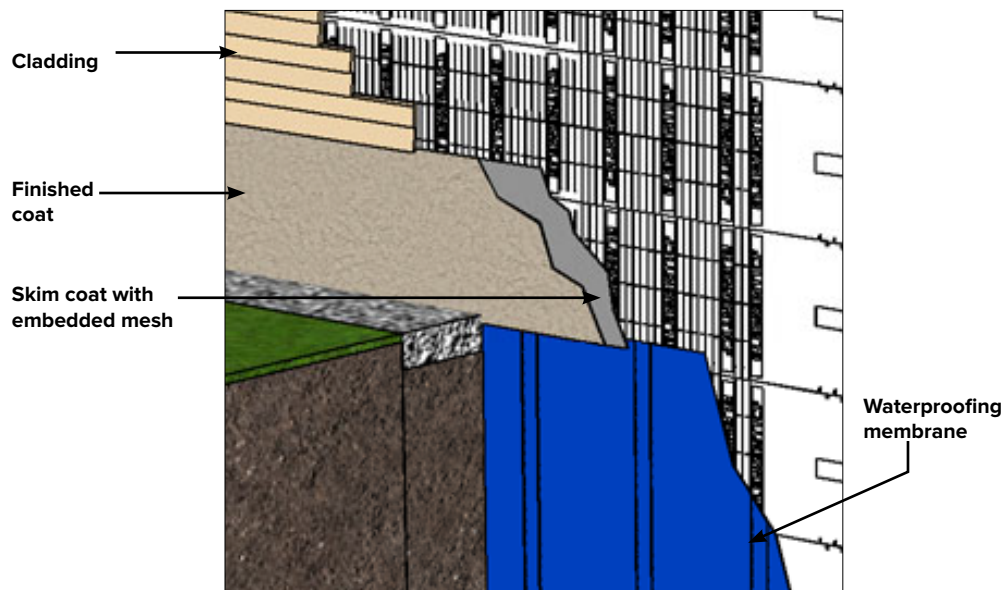

## 2.20 – ATTACHING FIXTURES

For attaching fixtures Element provides furring strips spaced every 8 inches, which provides more fastening points than stud walls.

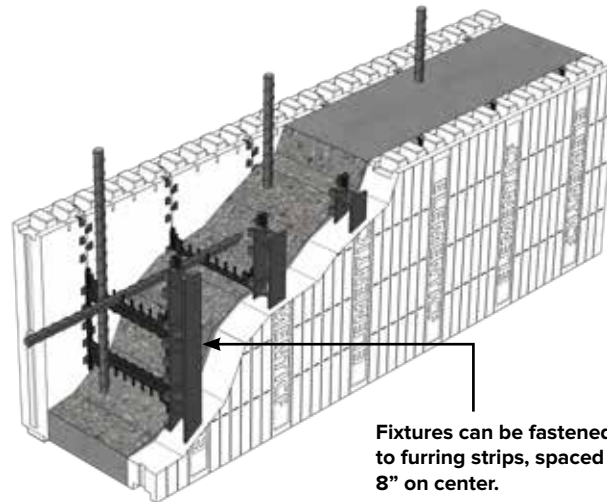

Different methods are used to attach fixtures depending on whether the fixture is light or heavy in weight.

### 2.20.1 - LIGHT WEIGHT FIXTURES

Fixtures that are light in weight, such as small picture frames or mirrors, can be attached to the wall without having to fasten into the furring strips by using typical hanging pins, finishing nails or plugs.

Fixtures such as curtain rods, large picture frames or mirrors, bathroom accessories, etc., require a more secure attachment to the wall.

### 2.20.2 - HEAVY WEIGHT FIXTURES

Additional backing is recommended to support heavier wall fixtures, such as kitchen cabinetry, wall mounted fixtures, grab bars, hand rails, etc.

Different attachment methods can be employed depending on the type of attachment.



2.20.2.1 – CABINETS

Fasten plywood to the embedded furring strips. Furring strip locations are marked with 'ELEMENTICF' pattern.

Plywood fastened to Element in lieu of drywall.

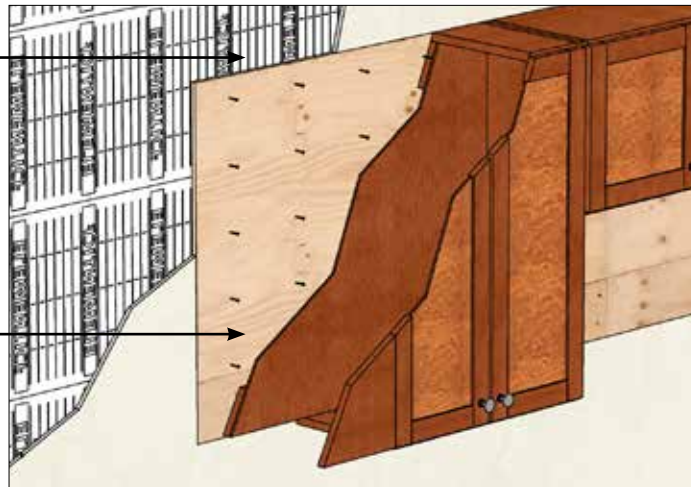

METHOD 1: Plywood board can be attached to the Element wall behind the heavier cabinets in place of gypsum board, providing a thermal barrier comparable to gypsum and a strong attachment surface for heavier items and fixtures. Be certain to attach the plywood board to the Element webs with a sufficient number of screws to hold heavy items in place for when loads are applied.

Cut strip of foam and place 2x4. Make sure 2x4 is flush to face of Element ICF. Anchor 2x4 to concrete.

Fasten cabinets to the 2x4s.

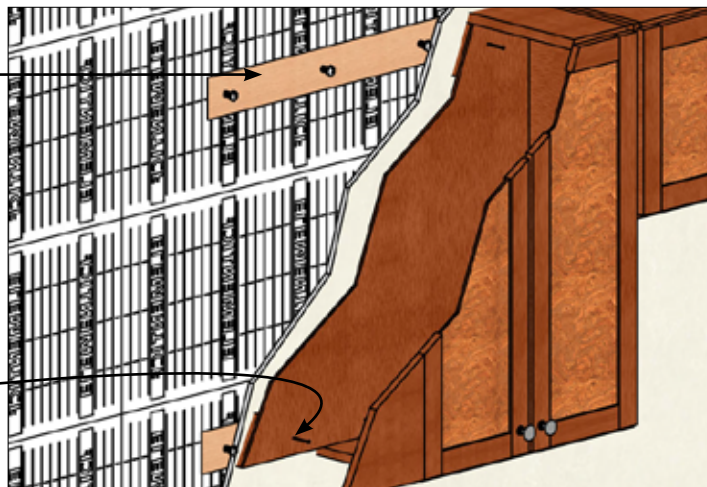

METHOD 2: Create horizontal channels behind the cabinets equal in width to a 2x4 and install 2x4 backing directly to the concrete surface using sufficiently long concrete screws and a rotohammer. Attach the cabinets to the 2x4s.

2.20.2.2 - GRAB BARS

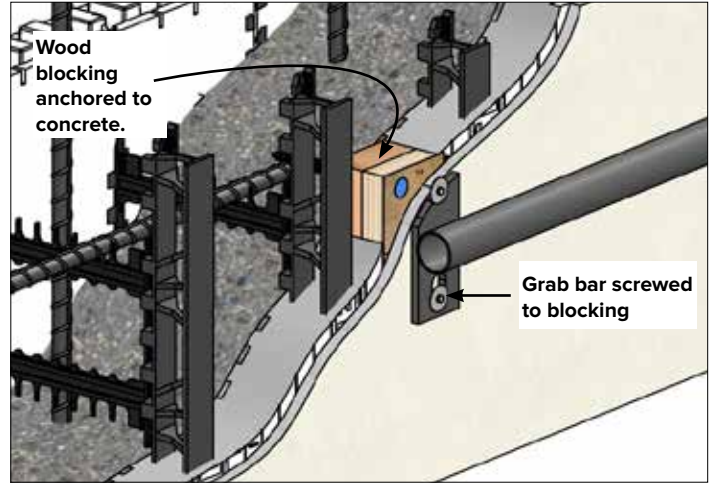
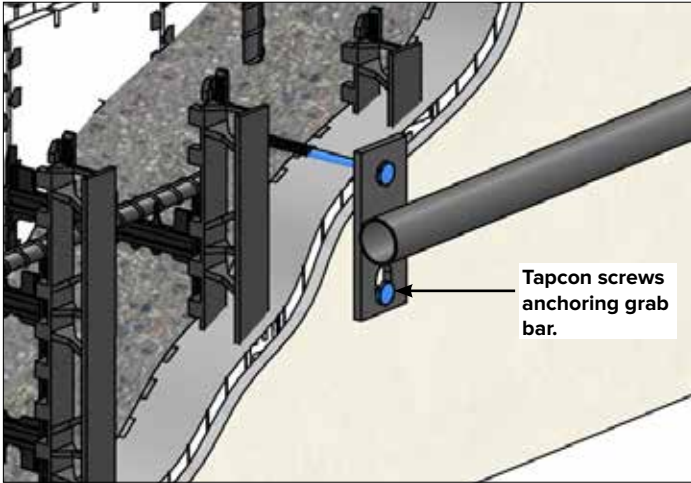

METHOD 1: Use Tapcon screws to anchor the grab bar directly to the concreted.

METHOD 2: For a stronger hold remove the foam and replace with wood blocking behind the grab bar mounting bracket. The wood blocking should be mechanically fastened to the concrete.

INSTALLATION GUIDE - HOLDING POWER OF SCREWS



2.20.2.3 – TELEVISIONS

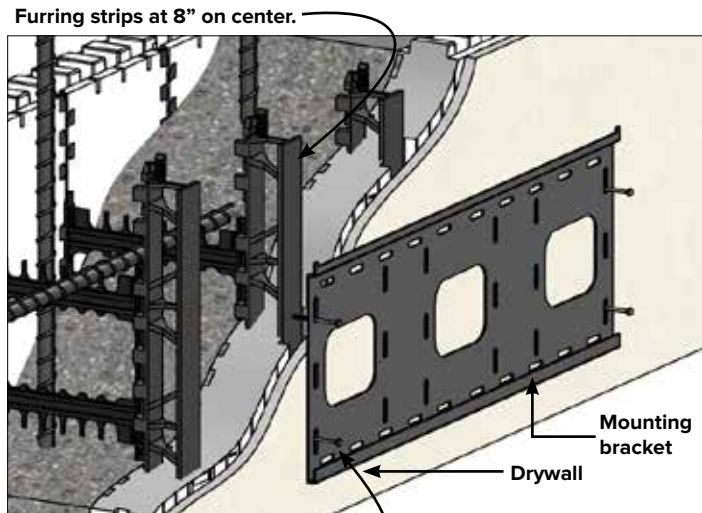

Coarse thread screws fastened to furring strips. Screws should penetrate at least 1/4” beyond furring strip.

METHOD 1: Face mounted TVs up to 200lbs can be secured to the furring strips with a minimum of 4 coarse thread screws. Care must be taken to ensure the screws are properly fastened to the furring strips.

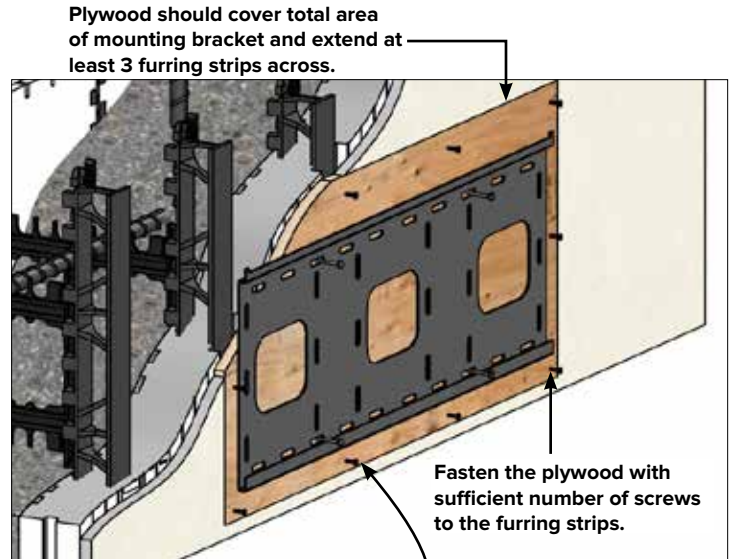

Before installing mounting bracket conceal plywood with drywall compound to blend with drywall (drywall compound not shown for clarity).

METHOD 2: Replace the drywall behind the mounting bracket with plywood.

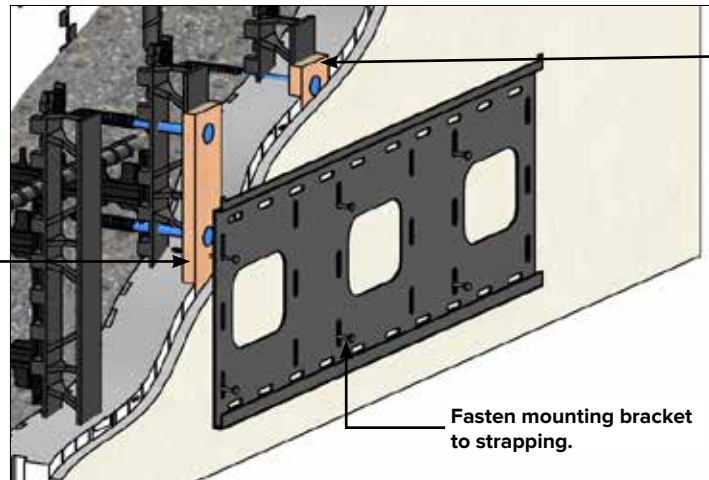

METHOD 3: TV mounts that swivel causes heavier loading conditions and should be anchored to the concrete with plywood and tapcons.

INSTALLATION GUIDE - HOLDING POWER OF SCREWS

## 2.21 – HOLDING POWER OF SCREWS FASTENED TO ELEMENT FURRING STRIPS

Web fastener withdrawal and shear testing using coarse and fine thread drywall screws. Tests were conducted on furring strips embedded 1/2 inch (52 mm) from the surface of the 2.75 inch (70 mm) Element EPS panels .

	Max. Average Withdrawal Resistance	Allowable Withdrawal Resistance <sup>1</sup>	Max. Average Shear Resistance	Allowable Shear Resistance <sup>2</sup>
Coarse Thread Drywall Screw	166lb (75.3kg)	33lb (15.0kg)	367lb (166.5kg)	49lb (22.2kg)
Fine Thread Drywall Screw	169lb (76.7kg)	34lb (15.4kg)	328lb (148.8kg)	49lb (22.2kg)

1kg = 9.81 Newtons

1. Allowable withdrawal resistance values are based on a factor of safety of 5.

2. Allowable shear resistance values are based on a factor of safety of 3.2 within defined deflection limits (for more detailed information contact info@Elementicf.com)

**NOTE:** The numbers in this table represent resistance at failure. Good building practice mandates a minimum of a 5 to 1 safety factor in calculating fastener loading. For complete test results on additional fasteners, see **Section 8** in the Element Design Manual or consult your local Element representative.



## 2.22 – RADIUS WALLS

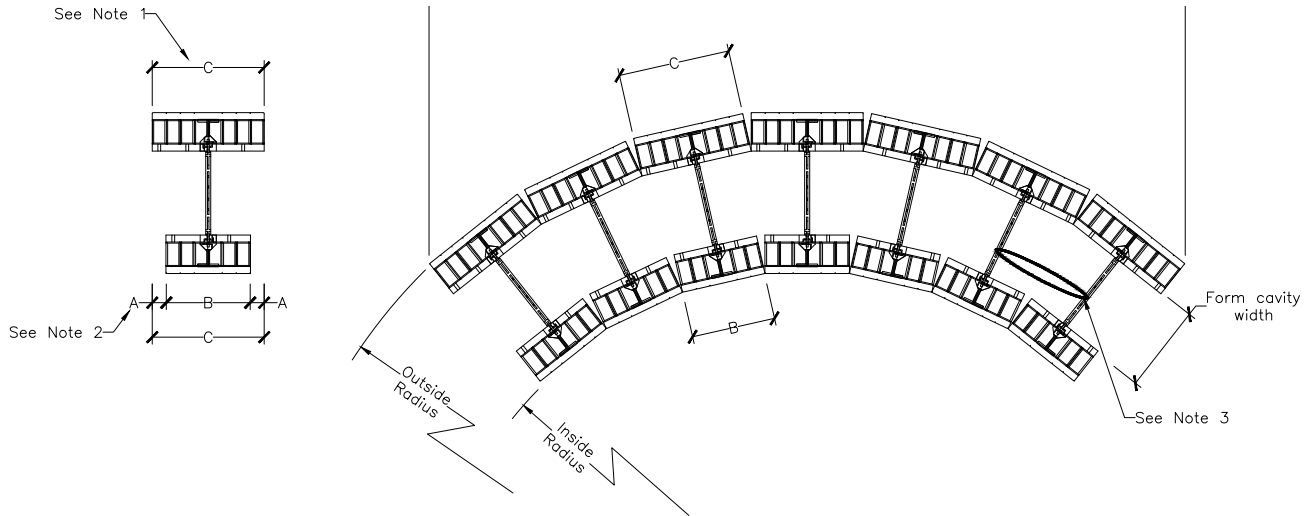

Outside Radius, ft. (m)	Form Cavity Width							
	4" (102mm)		6" (152mm)		8" (203mm)		10" (254mm)	
	C, in. (mm)	A, in. (mm)	C, in. (mm)	A, in. (mm)	C, in. (mm)	A, in. (mm)	C, in. (mm)	A, in. (mm)
<b>3 (0.914)</b>	8 (203)	13/16 (21)	8 (203)	1 1/16 (27)	8 (203)	1 19/64 (33)	8 (203)	1 35/64 (39)
<b>3.5 (1.067)</b>	8 (203)	11/16 (17)	8 (203)	57/64 (23)	8 (203)	1 3/32 (28)	8 (203)	1 19/64 (33)
<b>4 (1.219)</b>	8 (203)	19/32 (15)	8 (203)	49/64 (19)	8 (203)	61/64 (24)	8 (203)	1 1/8 (29)
<b>4.5 (1.372)</b>	8 (203)	17/32 (13)	8 (203)	11/16 (17)	8 (203)	27/32 (21)	8 (203)	1 (25)
<b>5 (1.524)</b>	8 (203)	15/32 (12)	8 (203)	39/64 (15)	8 (203)	3/4 (19)	8 (203)	57/64 (23)
<b>5.5 (1.676)</b>	8 (203)	27/64 (11)	8 (203)	35/64 (14)	8 (203)	43/64 (17)	8 (203)	51/64 (20)
<b>6 (1.829)</b>	8 (203)	25/64 (10)	8 (203)	1/2 (13)	8 (203)	5/8 (16)	8 (203)	47/64 (19)
<b>6.5 (1.981)</b>	8 (203)	23/64 (9)	8 (203)	15/32 (12)	8 (203)	9/16 (14)	8 (203)	43/64 (17)
<b>7 (2.134)</b>	8 (203)	21/64 (8)	8 (203)	27/64 (11)	8 (203)	17/32 (13)	8 (203)	5/8 (16)

**NOTES:**

1. Field cut Element Standard blocks (straight blocks) into widths, C, according to Element Radius Walls table. For inside radius field cut additional foam, A, accordingly.
2. Secure each radius section with zip ties, Element Hooks, tape or foam.
3. The field cuts, C, are kept at 8" (203mm), 16" (406mm), 24" (610mm) or 48" (1220mm) lengths. The field cuts, A, are determined depending on required radius. The combined field cuts, A and C, results in an outside radius which is within 1% of the design radius for radii less than 60ft (18.3m), and 1% to 2% for radii between 60ft and 100ft (18.3m to 30.5m).

Outside Radius, ft. (m)	Form Cavity Width							
	4" (102mm)		6" (152mm)		8" (203mm)		10" (254mm)	
	C, in. (mm)	A, in. (mm)	C, in. (mm)	A, in. (mm)	C, in. (mm)	A, in. (mm)	C, in. (mm)	A, in. (mm)
<b>7.5 (2.286)</b>	8 (203)	5/16 (8)	8 (203)	25/64 (10)	8 (203)	31/64 (12)	8 (203)	37/64 (15)
<b>8 (2.438)</b>	8 (203)	9/32 (7)	8 (203)	3/8 (10)	8 (203)	29/64 (12)	8 (203)	35/64 (14)
<b>8.5 (2.591)</b>	8 (203)	17/64 (7)	8 (203)	11/32 (9)	8 (203)	27/64 (11)	8 (203)	33/64 (13)
<b>9 (2.743)</b>	8 (203)	1/4 (6)	8 (203)	21/64 (8)	8 (203)	13/32 (10)	8 (203)	31/64 (12)
<b>9.5 (2.896)</b>	8 (203)	15/64 (6)	16 (406)	5/8 (16)	8 (203)	25/64 (10)	8 (203)	29/64 (12)
<b>10 (3.048)</b>	16 (406)	29/64 (12)	16 (406)	19/32 (15)	8 (203)	23/64 (9)	8 (203)	7/16 (11)
<b>10.5 (3.200)</b>	16 (406)	7/16 (11)	16 (406)	9/16 (14)	8 (203)	11/32 (9)	8 (203)	13/32 (10)
<b>11 (3.353)</b>	16 (406)	27/64 (11)	16 (406)	17/32 (13)	8 (203)	21/64 (8)	8 (203)	25/64 (10)
<b>11.5 (3.505)</b>	16 (406)	25/64 (10)	16 (406)	33/64 (13)	8 (203)	5/16 (8)	8 (203)	3/8 (10)
<b>12 (3.658)</b>	16 (406)	3/8 (10)	16 (406)	1/2 (13)	8 (203)	19/64 (8)	8 (203)	23/64 (9)
<b>12.5 (3.810)</b>	16 (406)	23/64 (9)	16 (406)	15/32 (12)	16 (406)	37/64 (15)	8 (203)	11/32 (9)
<b>13 (3.962)</b>	16 (406)	11/32 (9)	16 (406)	29/64 (12)	8 (203)	9/32 (7)	8 (203)	21/64 (8)
<b>13.5 (4.115)</b>	16 (406)	21/64 (8)	16 (406)	7/16 (11)	16 (406)	17/32 (13)	8 (203)	5/16 (8)
<b>14 (4.267)</b>	16 (406)	21/64 (8)	16 (406)	27/64 (11)	8 (203)	1/4 (6)	16 (406)	39/64 (15)
<b>14.5 (4.420)</b>	16 (406)	5/16 (8)	16 (406)	13/32 (10)	8 (203)	1/4 (6)	16 (406)	19/32 (15)
<b>15 (4.572)</b>	16 (406)	19/64 (8)	16 (406)	25/64 (10)	8 (203)	15/64 (6)	16 (406)	37/64 (15)
<b>15.5 (4.724)</b>	16 (406)	19/64 (8)	16 (406)	3/8 (10)	8 (203)	15/64 (6)	16 (406)	35/64 (14)
<b>16 (4.877)</b>	24 (610)	27/64 (11)	16 (406)	23/64 (9)	8 (203)	7/32 (6)	16 (406)	17/32 (13)
<b>16.5 (5.029)</b>	24 (610)	13/32 (10)	16 (406)	23/64 (9)	8 (203)	7/32 (6)	16 (406)	33/64 (13)
<b>17 (5.182)</b>	24 (610)	13/32 (10)	16 (406)	11/32 (9)	16 (406)	27/64 (11)	16 (406)	1/2 (13)
<b>17.5 (5.334)</b>	24 (610)	25/64 (10)	24 (610)	1/2 (13)	16 (406)	13/32 (10)	16 (406)	31/64 (12)
<b>18 (5.486)</b>	24 (610)	3/8 (10)	24 (610)	31/64 (12)	16 (406)	13/32 (10)	16 (406)	15/32 (12)
<b>18.5 (5.639)</b>	24 (610)	23/64 (9)	24 (610)	15/32 (12)	16 (406)	25/64 (10)	16 (406)	15/32 (12)
<b>19 (5.791)</b>	24 (610)	23/64 (9)	24 (610)	15/32 (12)	16 (406)	3/8 (10)	16 (406)	29/64 (12)





Outside Radius, ft. (m)	Form Cavity Width							
	4" (102mm)		6" (152mm)		8" (203mm)		10" (254mm)	
	C, in. (mm)	A, in. (mm)	C, in. (mm)	A, in. (mm)	C, in. (mm)	A, in. (mm)	C, in. (mm)	A, in. (mm)
19.5 (5.944)	24 (610)	11/32 (9)	24 (610)	29/64 (12)	16 (406)	3/8 (10)	16 (406)	7/16 (11)
20 (6.096)	24 (610)	11/32 (9)	24 (610)	7/16 (11)	16 (406)	23/64 (9)	16 (406)	27/64 (11)
20.5 (6.248)	24 (610)	21/64 (8)	24 (610)	27/64 (11)	16 (406)	11/32 (9)	16 (406)	27/64 (11)
21 (6.401)	24 (610)	21/64 (8)	24 (610)	27/64 (11)	16 (406)	11/32 (9)	16 (406)	13/32 (10)
21.5 (6.553)	24 (610)	5/16 (8)	24 (610)	13/32 (10)	16 (406)	21/64 (8)	16 (406)	25/64 (10)
22 (6.706)	24 (610)	5/16 (8)	24 (610)	25/64 (10)	16 (406)	21/64 (8)	16 (406)	25/64 (10)
22.5 (6.858)	24 (610)	19/64 (8)	24 (610)	25/64 (10)	16 (406)	5/16 (8)	16 (406)	3/8 (10)
23 (7.010)	24 (610)	19/64 (8)	24 (610)	3/8 (10)	16 (406)	5/16 (8)	16 (406)	3/8 (10)
23.5 (7.163)	24 (610)	9/32 (7)	24 (610)	3/8 (10)	24 (610)	29/64 (12)	16 (406)	23/64 (9)
24 (7.315)	24 (610)	9/32 (7)	24 (610)	23/64 (9)	24 (610)	29/64 (12)	16 (406)	23/64 (9)
24.5 (7.468)	24 (610)	9/32 (7)	48 (1,219)	23/32 (18)	24 (610)	7/16 (11)	16 (406)	11/32 (9)
25 (7.620)	24 (610)	17/64 (7)	48 (1,219)	45/64 (18)	24 (610)	7/16 (11)	16 (406)	11/32 (9)
25.5 (7.772)	24 (610)	17/64 (7)	48 (1,219)	11/16 (17)	24 (610)	27/64 (11)	16 (406)	21/64 (8)
26 (7.925)	48 (1,219)	33/64 (13)	48 (1,219)	43/64 (17)	24 (610)	13/32 (10)	16 (406)	21/64 (8)
26.5 (8.077)	48 (1,219)	33/64 (13)	48 (1,219)	43/64 (17)	24 (610)	13/32 (10)	16 (406)	5/16 (8)
27 (8.230)	48 (1,219)	1/2 (13)	48 (1,219)	21/32 (17)	24 (610)	25/64 (10)	16 (406)	5/16 (8)
27.5 (8.382)	48 (1,219)	1/2 (13)	48 (1,219)	41/64 (16)	24 (610)	25/64 (10)	16 (406)	5/16 (8)
28 (8.534)	48 (1,219)	31/64 (12)	48 (1,219)	5/8 (16)	24 (610)	25/64 (10)	16 (406)	19/64 (8)
28.5 (8.687)	48 (1,219)	15/32 (12)	48 (1,219)	39/64 (15)	24 (610)	3/8 (10)	24 (610)	29/64 (12)
29 (8.839)	48 (1,219)	15/32 (12)	48 (1,219)	39/64 (15)	24 (610)	3/8 (10)	24 (610)	7/16 (11)
29.5 (8.992)	48 (1,219)	29/64 (12)	48 (1,219)	19/32 (15)	24 (610)	23/64 (9)	24 (610)	7/16 (11)
30 (9.144)	48 (1,219)	29/64 (12)	48 (1,219)	37/64 (15)	24 (610)	23/64 (9)	24 (610)	27/64 (11)
30.5 (9.296)	48 (1,219)	7/16 (11)	48 (1,219)	37/64 (15)	48 (1,219)	45/64 (18)	24 (610)	27/64 (11)
31 (9.449)	48 (1,219)	7/16 (11)	48 (1,219)	9/16 (14)	48 (1,219)	45/64 (18)	24 (610)	13/32 (10)

INSTALLATION GUIDE - RADIUS WALLS

Outside Radius, ft. (m)	Form Cavity Width							
	4" (102mm)		6" (152mm)		8" (203mm)		10" (254mm)	
	C, in. (mm)	A, in. (mm)	C, in. (mm)	A, in. (mm)	C, in. (mm)	A, in. (mm)	C, in. (mm)	A, in. (mm)
<b>31.5 (9.601)</b>	48 (1,219)	27/64 (11)	48 (1,219)	9/16 (14)	48 (1,219)	11/16 (17)	24 (610)	13/32 (10)
<b>32 (9.754)</b>	48 (1,219)	27/64 (11)	48 (1,219)	35/64 (14)	48 (1,219)	43/64 (17)	24 (610)	25/64 (10)
<b>32.5 (9.906)</b>	48 (1,219)	27/64 (11)	48 (1,219)	35/64 (14)	48 (1,219)	21/32 (17)	24 (610)	25/64 (10)
<b>33 (10.058)</b>	48 (1,219)	13/32 (10)	48 (1,219)	17/32 (13)	48 (1,219)	21/32 (17)	24 (610)	25/64 (10)
<b>33.5 (10.211)</b>	48 (1,219)	13/32 (10)	48 (1,219)	33/64 (13)	48 (1,219)	41/64 (16)	24 (610)	3/8 (10)
<b>34 (10.363)</b>	48 (1,219)	25/64 (10)	48 (1,219)	33/64 (13)	48 (1,219)	41/64 (16)	24 (610)	3/8 (10)
<b>34.5 (10.516)</b>	48 (1,219)	25/64 (10)	48 (1,219)	1/2 (13)	48 (1,219)	5/8 (16)	24 (610)	3/8 (10)
<b>35 (10.668)</b>	48 (1,219)	25/64 (10)	48 (1,219)	1/2 (13)	48 (1,219)	39/64 (15)	24 (610)	23/64 (9)
<b>35.5 (10.820)</b>	48 (1,219)	3/8 (10)	48 (1,219)	1/2 (13)	48 (1,219)	39/64 (15)	24 (610)	23/64 (9)
<b>36 (10.973)</b>	48 (1,219)	3/8 (10)	48 (1,219)	31/64 (12)	48 (1,219)	19/32 (15)	24 (610)	23/64 (9)
<b>36.5 (11.125)</b>	48 (1,219)	3/8 (10)	48 (1,219)	31/64 (12)	48 (1,219)	19/32 (15)	24 (610)	11/32 (9)
<b>37 (11.278)</b>	48 (1,219)	23/64 (9)	48 (1,219)	15/32 (12)	48 (1,219)	37/64 (15)	24 (610)	11/32 (9)
<b>37.5 (11.430)</b>	48 (1,219)	23/64 (9)	48 (1,219)	15/32 (12)	48 (1,219)	37/64 (15)	24 (610)	11/32 (9)
<b>38 (11.582)</b>	48 (1,219)	23/64 (9)	48 (1,219)	29/64 (12)	48 (1,219)	9/16 (14)	24 (610)	21/64 (8)
<b>38.5 (11.735)</b>	48 (1,219)	11/32 (9)	48 (1,219)	29/64 (12)	48 (1,219)	9/16 (14)	24 (610)	21/64 (8)
<b>39 (11.887)</b>	48 (1,219)	11/32 (9)	48 (1,219)	29/64 (12)	48 (1,219)	35/64 (14)	24 (610)	21/64 (8)
<b>39.5 (12.040)</b>	48 (1,219)	11/32 (9)	48 (1,219)	7/16 (11)	48 (1,219)	35/64 (14)	24 (610)	21/64 (8)
<b>40 (12.192)</b>	48 (1,219)	11/32 (9)	48 (1,219)	7/16 (11)	48 (1,219)	17/32 (13)	24 (610)	5/16 (8)
<b>40.5 (12.344)</b>	48 (1,219)	21/64 (8)	48 (1,219)	7/16 (11)	48 (1,219)	17/32 (13)	48 (1,219)	5/8 (16)
<b>41 (12.497)</b>	48 (1,219)	21/64 (8)	48 (1,219)	27/64 (11)	48 (1,219)	17/32 (13)	48 (1,219)	5/8 (16)
<b>41.5 (12.649)</b>	48 (1,219)	21/64 (8)	48 (1,219)	27/64 (11)	48 (1,219)	33/64 (13)	48 (1,219)	39/64 (15)
<b>42 (12.802)</b>	48 (1,219)	5/16 (8)	48 (1,219)	27/64 (11)	48 (1,219)	33/64 (13)	48 (1,219)	39/64 (15)
<b>42.5 (12.954)</b>	48 (1,219)	5/16 (8)	48 (1,219)	13/32 (10)	48 (1,219)	1/2 (13)	48 (1,219)	19/32 (15)
<b>43 (13.106)</b>	48 (1,219)	5/16 (8)	48 (1,219)	13/32 (10)	48 (1,219)	1/2 (13)	48 (1,219)	19/32 (15)



Outside Radius, ft. (m)	Form Cavity Width							
	4" (102mm)		6" (152mm)		8" (203mm)		10" (254mm)	
	C, in. (mm)	A, in. (mm)	C, in. (mm)	A, in. (mm)	C, in. (mm)	A, in. (mm)	C, in. (mm)	A, in. (mm)
43.5 (13.259)	48 (1,219)	5/16 (8)	48 (1,219)	13/32 (10)	48 (1,219)	1/2 (13)	48 (1,219)	19/32 (15)
44 (13.411)	48 (1,219)	5/16 (8)	48 (1,219)	25/64 (10)	48 (1,219)	31/64 (12)	48 (1,219)	37/64 (15)
44.5 (13.564)	48 (1,219)	19/64 (8)	48 (1,219)	25/64 (10)	48 (1,219)	31/64 (12)	48 (1,219)	37/64 (15)
45 (13.716)	48 (1,219)	19/64 (8)	48 (1,219)	25/64 (10)	48 (1,219)	31/64 (12)	48 (1,219)	9/16 (14)
45.5 (13.868)	48 (1,219)	19/64 (8)	48 (1,219)	25/64 (10)	48 (1,219)	15/32 (12)	48 (1,219)	9/16 (14)
46 (14.021)	48 (1,219)	19/64 (8)	48 (1,219)	3/8 (10)	48 (1,219)	15/32 (12)	48 (1,219)	35/64 (14)
46.5 (14.173)	48 (1,219)	9/32 (7)	48 (1,219)	3/8 (10)	48 (1,219)	15/32 (12)	48 (1,219)	35/64 (14)
47 (14.326)	48 (1,219)	9/32 (7)	48 (1,219)	3/8 (10)	48 (1,219)	29/64 (12)	48 (1,219)	35/64 (14)
47.5 (14.478)	48 (1,219)	9/32 (7)	48 (1,219)	23/64 (9)	48 (1,219)	29/64 (12)	48 (1,219)	17/32 (13)
48 (14.630)	48 (1,219)	9/32 (7)	48 (1,219)	23/64 (9)	48 (1,219)	29/64 (12)	48 (1,219)	17/32 (13)
48.5 (14.783)	48 (1,219)	9/32 (7)	48 (1,219)	23/64 (9)	48 (1,219)	7/16 (11)	48 (1,219)	17/32 (13)
49 (14.935)	48 (1,219)	17/64 (7)	48 (1,219)	23/64 (9)	48 (1,219)	7/16 (11)	48 (1,219)	33/64 (13)
49.5 (15.088)	48 (1,219)	17/64 (7)	48 (1,219)	23/64 (9)	48 (1,219)	7/16 (11)	48 (1,219)	33/64 (13)
50 (15.240)	48 (1,219)	17/64 (7)	48 (1,219)	11/32 (9)	48 (1,219)	27/64 (11)	48 (1,219)	33/64 (13)
50.5 (15.392)	48 (1,219)	17/64 (7)	48 (1,219)	11/32 (9)	48 (1,219)	27/64 (11)	48 (1,219)	1/2 (13)
51 (15.545)	48 (1,219)	17/64 (7)	48 (1,219)	11/32 (9)	48 (1,219)	27/64 (11)	48 (1,219)	1/2 (13)
51.5 (15.697)	48 (1,219)	17/64 (7)	48 (1,219)	11/32 (9)	48 (1,219)	27/64 (11)	48 (1,219)	1/2 (13)
52 (15.850)	48 (1,219)	1/4 (6)	48 (1,219)	21/64 (8)	48 (1,219)	13/32 (10)	48 (1,219)	31/64 (12)
52.5 (16.002)	48 (1,219)	1/4 (6)	48 (1,219)	21/64 (8)	48 (1,219)	13/32 (10)	48 (1,219)	31/64 (12)
53 (16.154)	48 (1,219)	1/4 (6)	48 (1,219)	21/64 (8)	48 (1,219)	13/32 (10)	48 (1,219)	31/64 (12)
53.5 (16.307)	48 (1,219)	1/4 (6)	48 (1,219)	21/64 (8)	48 (1,219)	13/32 (10)	48 (1,219)	15/32 (12)
54 (16.459)	48 (1,219)	1/4 (6)	48 (1,219)	21/64 (8)	48 (1,219)	25/64 (10)	48 (1,219)	15/32 (12)
54.5 (16.612)	48 (1,219)	1/4 (6)	48 (1,219)	5/16 (8)	48 (1,219)	25/64 (10)	48 (1,219)	15/32 (12)
55 (16.764)	48 (1,219)	1/4 (6)	48 (1,219)	5/16 (8)	48 (1,219)	25/64 (10)	48 (1,219)	15/32 (12)

INSTALLATION GUIDE - RADIUS WALLS

Outside Radius, ft. (m)	Form Cavity Width							
	4" (102mm)		6" (152mm)		8" (203mm)		10" (254mm)	
	C, in. (mm)	A, in. (mm)	C, in. (mm)	A, in. (mm)	C, in. (mm)	A, in. (mm)	C, in. (mm)	A, in. (mm)
<b>55.5 (16.916)</b>	48 (1,219)	15/64 (6)	48 (1,219)	5/16 (8)	48 (1,219)	25/64 (10)	48 (1,219)	29/64 (12)
<b>56 (17.069)</b>	48 (1,219)	15/64 (6)	48 (1,219)	5/16 (8)	48 (1,219)	3/8 (10)	48 (1,219)	29/64 (12)
<b>56.5 (17.221)</b>	48 (1,219)	15/64 (6)	48 (1,219)	5/16 (8)	48 (1,219)	3/8 (10)	48 (1,219)	29/64 (12)
<b>57 (17.374)</b>	48 (1,219)	15/64 (6)	48 (1,219)	19/64 (8)	48 (1,219)	3/8 (10)	48 (1,219)	29/64 (12)
<b>57.5 (17.526)</b>	48 (1,219)	15/64 (6)	48 (1,219)	19/64 (8)	48 (1,219)	3/8 (10)	48 (1,219)	7/16 (11)
<b>58 (17.678)</b>	48 (1,219)	15/64 (6)	48 (1,219)	19/64 (8)	48 (1,219)	3/8 (10)	48 (1,219)	7/16 (11)
<b>58.5 (17.831)</b>	48 (1,219)	15/64 (6)	48 (1,219)	19/64 (8)	48 (1,219)	23/64 (9)	48 (1,219)	7/16 (11)
<b>59 (17.983)</b>	48 (1,219)	7/32 (6)	48 (1,219)	19/64 (8)	48 (1,219)	23/64 (9)	48 (1,219)	7/16 (11)
<b>59.5 (18.136)</b>	48 (1,219)	7/32 (6)	48 (1,219)	19/64 (8)	48 (1,219)	23/64 (9)	48 (1,219)	27/64 (11)
<b>60 (18.288)</b>	48 (1,219)	7/32 (6)	48 (1,219)	9/32 (7)	48 (1,219)	23/64 (9)	48 (1,219)	27/64 (11)
<b>60.5 (18.440)</b>	48 (1,219)	7/32 (6)	48 (1,219)	9/32 (7)	48 (1,219)	23/64 (9)	48 (1,219)	27/64 (11)
<b>61 (18.593)</b>	48 (1,219)	7/32 (6)	48 (1,219)	9/32 (7)	48 (1,219)	11/32 (9)	48 (1,219)	27/64 (11)
<b>61.5 (18.745)</b>	48 (1,219)	7/32 (6)	48 (1,219)	9/32 (7)	48 (1,219)	11/32 (9)	48 (1,219)	13/32 (10)
<b>62 (18.898)</b>	48 (1,219)	7/32 (6)	48 (1,219)	9/32 (7)	48 (1,219)	11/32 (9)	48 (1,219)	13/32 (10)
<b>62.5 (19.050)</b>	48 (1,219)	7/32 (6)	48 (1,219)	9/32 (7)	48 (1,219)	11/32 (9)	48 (1,219)	13/32 (10)
<b>63 (19.202)</b>	48 (1,219)	7/32 (6)	48 (1,219)	9/32 (7)	48 (1,219)	11/32 (9)	48 (1,219)	13/32 (10)
<b>63.5 (19.355)</b>	48 (1,219)	13/64 (5)	48 (1,219)	17/64 (7)	48 (1,219)	11/32 (9)	48 (1,219)	13/32 (10)
<b>64 (19.507)</b>	48 (1,219)	13/64 (5)	48 (1,219)	17/64 (7)	48 (1,219)	21/64 (8)	48 (1,219)	25/64 (10)
<b>64.5 (19.660)</b>	48 (1,219)	13/64 (5)	48 (1,219)	17/64 (7)	48 (1,219)	21/64 (8)	48 (1,219)	25/64 (10)
<b>65 (19.812)</b>	48 (1,219)	13/64 (5)	48 (1,219)	17/64 (7)	48 (1,219)	21/64 (8)	48 (1,219)	25/64 (10)
<b>65.5 (19.964)</b>	48 (1,219)	13/64 (5)	48 (1,219)	17/64 (7)	48 (1,219)	21/64 (8)	48 (1,219)	25/64 (10)
<b>66 (20.117)</b>	48 (1,219)	13/64 (5)	48 (1,219)	17/64 (7)	48 (1,219)	21/64 (8)	48 (1,219)	25/64 (10)
<b>66.5 (20.269)</b>	48 (1,219)	13/64 (5)	48 (1,219)	17/64 (7)	48 (1,219)	21/64 (8)	48 (1,219)	3/8 (10)
<b>67 (20.422)</b>	48 (1,219)	13/64 (5)	48 (1,219)	17/64 (7)	48 (1,219)	5/16 (8)	48 (1,219)	3/8 (10)



Outside Radius, ft. (m)	Form Cavity Width							
	4" (102mm)		6" (152mm)		8" (203mm)		10" (254mm)	
	C, in. (mm)	A, in. (mm)	C, in. (mm)	A, in. (mm)	C, in. (mm)	A, in. (mm)	C, in. (mm)	A, in. (mm)
<b>67.5 (20.574)</b>	48 (1,219)	13/64 (5)	48 (1,219)	1/4 (6)	48 (1,219)	5/16 (8)	48 (1,219)	3/8 (10)
<b>68 (20.726)</b>	48 (1,219)	13/64 (5)	48 (1,219)	1/4 (6)	48 (1,219)	5/16 (8)	48 (1,219)	3/8 (10)
<b>68.5 (20.879)</b>	48 (1,219)	3/16 (5)	48 (1,219)	1/4 (6)	48 (1,219)	5/16 (8)	48 (1,219)	3/8 (10)
<b>69 (21.031)</b>	48 (1,219)	3/16 (5)	48 (1,219)	1/4 (6)	48 (1,219)	5/16 (8)	48 (1,219)	23/64 (9)
<b>69.5 (21.184)</b>	48 (1,219)	3/16 (5)	48 (1,219)	1/4 (6)	48 (1,219)	5/16 (8)	48 (1,219)	23/64 (9)
<b>70 (21.336)</b>	48 (1,219)	3/16 (5)	48 (1,219)	1/4 (6)	48 (1,219)	19/64 (8)	48 (1,219)	23/64 (9)
<b>70.5 (21.488)</b>	48 (1,219)	3/16 (5)	48 (1,219)	1/4 (6)	48 (1,219)	19/64 (8)	48 (1,219)	23/64 (9)
<b>71 (21.641)</b>	48 (1,219)	3/16 (5)	48 (1,219)	1/4 (6)	48 (1,219)	19/64 (8)	48 (1,219)	23/64 (9)
<b>71.5 (21.793)</b>	48 (1,219)	3/16 (5)	48 (1,219)	15/64 (6)	48 (1,219)	19/64 (8)	48 (1,219)	23/64 (9)
<b>72 (21.946)</b>	48 (1,219)	3/16 (5)	48 (1,219)	15/64 (6)	48 (1,219)	19/64 (8)	48 (1,219)	11/32 (9)
<b>72.5 (22.098)</b>	48 (1,219)	3/16 (5)	48 (1,219)	15/64 (6)	48 (1,219)	19/64 (8)	48 (1,219)	11/32 (9)
<b>73 (22.250)</b>	48 (1,219)	3/16 (5)	48 (1,219)	15/64 (6)	48 (1,219)	19/64 (8)	48 (1,219)	11/32 (9)
<b>73.5 (22.403)</b>	48 (1,219)	3/16 (5)	48 (1,219)	15/64 (6)	48 (1,219)	19/64 (8)	48 (1,219)	11/32 (9)
<b>74 (22.555)</b>	48 (1,219)	11/64 (4)	48 (1,219)	15/64 (6)	48 (1,219)	9/32 (7)	48 (1,219)	11/32 (9)
<b>74.5 (22.708)</b>	48 (1,219)	11/64 (4)	48 (1,219)	15/64 (6)	48 (1,219)	9/32 (7)	48 (1,219)	11/32 (9)
<b>75 (22.860)</b>	48 (1,219)	11/64 (4)	48 (1,219)	15/64 (6)	48 (1,219)	9/32 (7)	48 (1,219)	11/32 (9)
<b>75.5 (23.012)</b>	48 (1,219)	11/64 (4)	48 (1,219)	15/64 (6)	48 (1,219)	9/32 (7)	48 (1,219)	21/64 (8)
<b>76 (23.165)</b>	48 (1,219)	11/64 (4)	48 (1,219)	15/64 (6)	48 (1,219)	9/32 (7)	48 (1,219)	21/64 (8)
<b>76.5 (23.317)</b>	48 (1,219)	11/64 (4)	48 (1,219)	7/32 (6)	48 (1,219)	9/32 (7)	48 (1,219)	21/64 (8)
<b>77 (23.470)</b>	48 (1,219)	11/64 (4)	48 (1,219)	7/32 (6)	48 (1,219)	9/32 (7)	48 (1,219)	21/64 (8)
<b>77.5 (23.622)</b>	48 (1,219)	11/64 (4)	48 (1,219)	7/32 (6)	48 (1,219)	9/32 (7)	48 (1,219)	21/64 (8)
<b>78 (23.774)</b>	48 (1,219)	11/64 (4)	48 (1,219)	7/32 (6)	48 (1,219)	17/64 (7)	48 (1,219)	21/64 (8)
<b>78.5 (23.927)</b>	48 (1,219)	11/64 (4)	48 (1,219)	7/32 (6)	48 (1,219)	17/64 (7)	48 (1,219)	21/64 (8)
<b>79 (24.079)</b>	48 (1,219)	11/64 (4)	48 (1,219)	7/32 (6)	48 (1,219)	17/64 (7)	48 (1,219)	5/16 (8)

INSTALLATION GUIDE - RADIUS WALLS

Outside Radius, ft. (m)	Form Cavity Width							
	4" (102mm)		6" (152mm)		8" (203mm)		10" (254mm)	
	C, in. (mm)	A, in. (mm)	C, in. (mm)	A, in. (mm)	C, in. (mm)	A, in. (mm)	C, in. (mm)	A, in. (mm)
<b>79.5 (24.232)</b>	48 (1,219)	11/64 (4)	48 (1,219)	7/32 (6)	48 (1,219)	17/64 (7)	48 (1,219)	5/16 (8)
<b>80 (24.384)</b>	48 (1,219)	11/64 (4)	48 (1,219)	7/32 (6)	48 (1,219)	17/64 (7)	48 (1,219)	5/16 (8)
<b>80.5 (24.536)</b>	48 (1,219)	11/64 (4)	48 (1,219)	7/32 (6)	48 (1,219)	17/64 (7)	48 (1,219)	5/16 (8)
<b>81 (24.689)</b>	48 (1,219)	5/32 (4)	48 (1,219)	7/32 (6)	48 (1,219)	17/64 (7)	48 (1,219)	5/16 (8)
<b>81.5 (24.841)</b>	48 (1,219)	5/32 (4)	48 (1,219)	7/32 (6)	48 (1,219)	17/64 (7)	48 (1,219)	5/16 (8)
<b>82 (24.994)</b>	48 (1,219)	5/32 (4)	48 (1,219)	13/64 (5)	48 (1,219)	17/64 (7)	48 (1,219)	5/16 (8)
<b>82.5 (25.146)</b>	48 (1,219)	5/32 (4)	48 (1,219)	13/64 (5)	48 (1,219)	1/4 (6)	48 (1,219)	5/16 (8)
<b>83 (25.298)</b>	48 (1,219)	5/32 (4)	48 (1,219)	13/64 (5)	48 (1,219)	1/4 (6)	48 (1,219)	19/64 (8)
<b>83.5 (25.451)</b>	48 (1,219)	5/32 (4)	48 (1,219)	13/64 (5)	48 (1,219)	1/4 (6)	48 (1,219)	19/64 (8)
<b>84 (25.603)</b>	48 (1,219)	5/32 (4)	48 (1,219)	13/64 (5)	48 (1,219)	1/4 (6)	48 (1,219)	19/64 (8)
<b>84.5 (25.756)</b>	48 (1,219)	5/32 (4)	48 (1,219)	13/64 (5)	48 (1,219)	1/4 (6)	48 (1,219)	19/64 (8)
<b>85 (25.908)</b>	48 (1,219)	5/32 (4)	48 (1,219)	13/64 (5)	48 (1,219)	1/4 (6)	48 (1,219)	19/64 (8)
<b>85.5 (26.060)</b>	48 (1,219)	5/32 (4)	48 (1,219)	13/64 (5)	48 (1,219)	1/4 (6)	48 (1,219)	19/64 (8)
<b>86 (26.213)</b>	48 (1,219)	5/32 (4)	48 (1,219)	13/64 (5)	48 (1,219)	1/4 (6)	48 (1,219)	19/64 (8)
<b>86.5 (26.365)</b>	48 (1,219)	5/32 (4)	48 (1,219)	13/64 (5)	48 (1,219)	1/4 (6)	48 (1,219)	19/64 (8)
<b>87 (26.518)</b>	48 (1,219)	5/32 (4)	48 (1,219)	13/64 (5)	48 (1,219)	1/4 (6)	48 (1,219)	19/64 (8)
<b>87.5 (26.670)</b>	48 (1,219)	5/32 (4)	48 (1,219)	13/64 (5)	48 (1,219)	1/4 (6)	48 (1,219)	9/32 (7)
<b>88 (26.822)</b>	48 (1,219)	5/32 (4)	48 (1,219)	13/64 (5)	48 (1,219)	15/64 (6)	48 (1,219)	9/32 (7)
<b>88.5 (26.975)</b>	48 (1,219)	5/32 (4)	48 (1,219)	3/16 (5)	48 (1,219)	15/64 (6)	48 (1,219)	9/32 (7)
<b>89 (27.127)</b>	48 (1,219)	9/64 (4)	48 (1,219)	3/16 (5)	48 (1,219)	15/64 (6)	48 (1,219)	9/32 (7)
<b>89.5 (27.280)</b>	48 (1,219)	9/64 (4)	48 (1,219)	3/16 (5)	48 (1,219)	15/64 (6)	48 (1,219)	9/32 (7)
<b>90 (27.432)</b>	48 (1,219)	9/64 (4)	48 (1,219)	3/16 (5)	48 (1,219)	15/64 (6)	48 (1,219)	9/32 (7)
<b>90.5 (27.584)</b>	48 (1,219)	9/64 (4)	48 (1,219)	3/16 (5)	48 (1,219)	15/64 (6)	48 (1,219)	9/32 (7)
<b>91 (27.737)</b>	48 (1,219)	9/64 (4)	48 (1,219)	3/16 (5)	48 (1,219)	15/64 (6)	48 (1,219)	9/32 (7)



Outside Radius, ft. (m)	Form Cavity Width							
	4" (102mm)		6" (152mm)		8" (203mm)		10" (254mm)	
	C, in. (mm)	A, in. (mm)	C, in. (mm)	A, in. (mm)	C, in. (mm)	A, in. (mm)	C, in. (mm)	A, in. (mm)
<b>91.5 (27.889)</b>	48 (1,219)	9/64 (4)	48 (1,219)	3/16 (5)	48 (1,219)	15/64 (6)	48 (1,219)	9/32 (7)
<b>92 (28.042)</b>	48 (1,219)	9/64 (4)	48 (1,219)	3/16 (5)	48 (1,219)	15/64 (6)	48 (1,219)	9/32 (7)
<b>92.5 (28.194)</b>	48 (1,219)	9/64 (4)	48 (1,219)	3/16 (5)	48 (1,219)	15/64 (6)	48 (1,219)	17/64 (7)
<b>93 (28.346)</b>	48 (1,219)	9/64 (4)	48 (1,219)	3/16 (5)	48 (1,219)	15/64 (6)	48 (1,219)	17/64 (7)
<b>93.5 (28.499)</b>	48 (1,219)	9/64 (4)	48 (1,219)	3/16 (5)	48 (1,219)	15/64 (6)	48 (1,219)	17/64 (7)
<b>94 (28.651)</b>	48 (1,219)	9/64 (4)	48 (1,219)	3/16 (5)	48 (1,219)	7/32 (6)	48 (1,219)	17/64 (7)
<b>94.5 (28.804)</b>	48 (1,219)	9/64 (4)	48 (1,219)	3/16 (5)	48 (1,219)	7/32 (6)	48 (1,219)	17/64 (7)
<b>95 (28.956)</b>	48 (1,219)	9/64 (4)	48 (1,219)	3/16 (5)	48 (1,219)	7/32 (6)	48 (1,219)	17/64 (7)
<b>95.5 (29.108)</b>	48 (1,219)	9/64 (4)	48 (1,219)	3/16 (5)	48 (1,219)	7/32 (6)	48 (1,219)	17/64 (7)
<b>96 (29.261)</b>	48 (1,219)	9/64 (4)	48 (1,219)	11/64 (4)	48 (1,219)	7/32 (6)	48 (1,219)	17/64 (7)
<b>96.5 (29.413)</b>	48 (1,219)	9/64 (4)	48 (1,219)	11/64 (4)	48 (1,219)	7/32 (6)	48 (1,219)	17/64 (7)
<b>97 (29.566)</b>	48 (1,219)	9/64 (4)	48 (1,219)	11/64 (4)	48 (1,219)	7/32 (6)	48 (1,219)	17/64 (7)
<b>97.5 (29.718)</b>	48 (1,219)	9/64 (4)	48 (1,219)	11/64 (4)	48 (1,219)	7/32 (6)	48 (1,219)	17/64 (7)
<b>98 (29.870)</b>	48 (1,219)	9/64 (4)	48 (1,219)	11/64 (4)	48 (1,219)	7/32 (6)	48 (1,219)	1/4 (6)
<b>98.5 (30.023)</b>	48 (1,219)	9/64 (4)	48 (1,219)	11/64 (4)	48 (1,219)	7/32 (6)	48 (1,219)	1/4 (6)
<b>99 (30.175)</b>	48 (1,219)	1/8 (3)	48 (1,219)	11/64 (4)	48 (1,219)	7/32 (6)	48 (1,219)	1/4 (6)
<b>99.5 (30.328)</b>	48 (1,219)	1/8 (3)	48 (1,219)	11/64 (4)	48 (1,219)	7/32 (6)	48 (1,219)	1/4 (6)
<b>100 (30.480)</b>	48 (1,219)	1/8 (3)	48 (1,219)	11/64 (4)	48 (1,219)	7/32 (6)	48 (1,219)	1/4 (6)

## 2.23 – TALL WALLS

Element walls can be constructed to any height provided proper engineering and construction methods are used. (Note: the pictures on this page are of tall wall projects built with Logix ICF and are being used to illustrate the principles of constructing ICF tall walls.)

Element tall walls should be designed in accordance with ACI 318 or CAN/CSA A23.3.



Constructing tall walls follows the same basic steps described throughout Section 2. In addition, building taller walls is done in much the same way as concrete pours using traditional formwork. Generally, Element blocks are stacked and braced, normally 10 to 12 feet high. The concrete is then placed. After the concrete sets Element blocks are then stacked another 10 to 12 feet, and bracing is raised or extended higher to support the wall, as well as keeping the wall plumb. This process is continued until the specified wall height is reached.





To ensure a smooth build, the following items should be considered:

- Load tables in the Element Prescriptive Engineering manual can be used as a design aid for both the builder and designer. However, tall wall designs should be reviewed and approved by a locally licensed professional engineer.
- In higher wind areas taller walls may require guy wires for additional support. Typically, this will be determined by the engineer of record.
- Proper consolidation of concrete can be achieved by adequate vibrating. However, depending on the drop height, and the steel congestion, external vibration, in addition to internal vibration, should be considered, particularly at corners, openings, and congested areas of rebar. (External vibrators made specifically for ICFs are available. See Section “2.24 – SUPPORTING PRODUCTS” on page 106.
- Since tall walls are typically poured using a pump truck, using a 2 1/2” trimmer hose can provide better control of the concrete pour.
- If required, roughen the surface of all cold joints to ensure a good bond between the surface of the old pour and the subsequent pour. In addition, ensure adequate rebar embedments are provided.
- For the final stage of the pour, an Element Taper Top block can be used, if required, for the top course of the wall. This provides a larger opening for concrete to flow into the wall and also provides a larger bearing area for supporting elements.
- Several tall wall bracing and alignment systems are available. For more information see Section 3.2, Tall Wall Bracing Systems.

NOTE: Both ACI 318 and CAN/CSA A23.3 permit cold joints when concrete is poured in stages.

## 2.24 – SUPPORTING PRODUCTS

A list of supporting ICF products are shown below. Consult with the listed manufacturer prior to using with Element Insulated Concrete Blocks. Please note: the products listed below does not prohibit the use of Element ICFs with other supporting products not listed.

### FOOTINGS

Product Name	Manufacturer	Contact	Website
Block-A-Drain	CertainTeed Corp.	708-301-4449	certainteed.com

### EXTERIOR FINISHES

Product Name	Manufacturer	Contact	Website
Durock	Alfacing International Ltd.	1-888-238-6345	durock.com
Senerflex	Degussa Wall Systems, Inc.	1-800-221-9255	senergy.cc
Sto EIFS System	Sto Corp.	1-800-221-2397	stocorp.com
GrailCoat	GrailCoat	1-877-472-4528	grailcoat.com
TAFS (Textured Acrylic Finishes)	dryvit	1-800-263-3308	dryvit.com
SoftCoat PB System	Total Wall, Inc.	1-888-702-9915	totalwall.com
Akroflex	Omega Products Corp.	602-721-5027	omega-products.com
Impact System	parex	1-800-537-2739	parex.com
PermaCrete	Quality Systems	1-800-607-3762	permacrete.com
Crack Guard	Poly-Wall	1-800-846-3020	poly-wall.com
Protecto Bond	Protecto Wrap	1-800-759-9727	protecowrap.com
WeatherWall Systems	Eco Specialty Products Ltd.	1-888-481-5507	eco coatings.ca

### WATERPROOFING

Product Name	Manufacturer	Contact	Website
System III	Epro	1-800-882-1896	eproserv.com
Blueskin WP2000	Bakor, Inc	1-800-387-9598	bakor.com
Colphene 3000	Soprema, Inc	1-800 567-1492	soprema.com
Delta-MS Clear	Cosella-Dorken Products, Inc.	1-888-4DELTA4	cosella-dorken.com
Platon	Armtec Ltd.	1-800-265-7622	systemplaton.com
Tamko TW60	Tamko, Inc.	1-800-641-4691	tamko.com
Grace waterproofing products	Grace Construction Products	See website	graceconstruction.com
Aqua-Wrap/Green Sheild	Aqua Seal Inc.	1-888-282-3861	aquasealusa.com

### CONNECTION SYSTEMS

Product Name	Manufacturer	Contact	Website
ICF Ledger Connector System	Simpson Strong-Tie Co., Inc.	1-800-999-5099	simpsonstrongtie.com
ICF-Connect	ICF-Connect Ltd.	1-866-497-1576	icfconnect.com



**ADHESIVE & SEALANTS**

Product Name	Manufacturer	Contact	Website
Enerfoam Sealant/Enerbond Adhesive	Dow Chemical Company	1-800-800-FOAM	dow.com/buildingproducts
PL300	Loctite	1-800-624-7767	www.loctiteproducts.com

**WALL BRACING & ALIGNMENT SYSTEMS**

Product Name	Manufacturer	Contact	Website
Uniscaffold, LLC	Uniscaffold	1-208-791-5624	www.uniscaffold.com
Giraffe Bracing	Giraffe Bracing	1-888-778-2285	www.giraffebracing.com
Plumwall	Plumwall Ltd.	1-905-786-7586	www.plumwall.com
Mono-Brace	Tapco	814-336-6549	www.mono-brace.com
Amazing Brace	Lakeland Group	905-372-7413	www.lakeland-multitrade.com

**EXTERNAL VIBRATORS**

Product Name	Manufacturer	Contact	Website
Brecon	Brecon Inc.	815-463-8073	http://icfvibrator.com
Arkie Wall Banger	Available from Wind-lock	1-800-872-5625	-

**SUPPLIERS OF SUPPORTING ICF PRODUCTS**

Company	Contact	Website
Wind-lock	1-800-872-5625	wind-lock.com
Grace Construction Products	See website	graceconstruction.com



## CONNECT WITH A LOCAL MANUFACTURER

**888.838.5038**

330 Cain Drive  
Haysville, KS 67060-2004

**888.453.5961**

11581-272 St.  
Acheson, AB T7X 6E9

**888.706.7709**

840 Division St.  
Cobourg, ON K9A 5V2

**888.453.5961**

6333 Unsworth Rd.  
Chilliwack, BC V2R 5M3

**877.789.7622**

35 Headingley Rd.  
Headingley, MB R4H 0A8

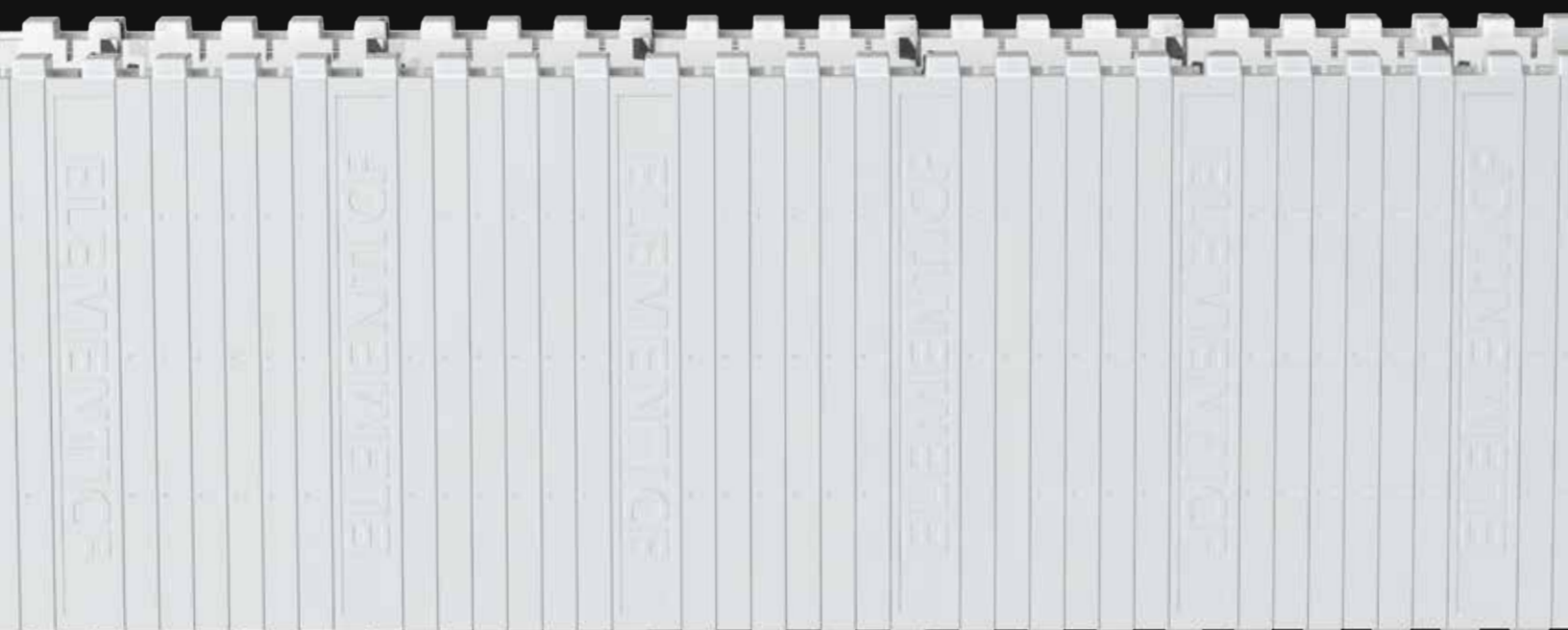

© Copyright Logix Brands Ltd. (2023) All rights reserved.

No part of the work contained herein as covered by this copyright may be reproduced or used in any form, or any means – graphic, electronic or mechanical, including without limitation photocopying. By using these products, you agree to assume all risks associated therewith. See [LogixBrands.com/Disclaimer-General](https://LogixBrands.com/Disclaimer-General) for a full copy of disclaimer.

**ELEMENTICF**<sup>®</sup>  
LOGIX BRANDS

[info@elementicf.com](mailto:info@elementicf.com)  
[Elementicf.com](https://Elementicf.com)

A PRODUCT BY  
**LOGIX**<sup>®</sup>  
BRANDS